

**EASTERN MEDITERRANEAN UNIVERSITY  
DEPARTMENT OF ARCHITECTURE**

**ARCH 246  
ENVIRONMENTAL CONTROL  
NOTES, GRAPHS AND CHARTS**

**Instructor**

**Assoc. Prof. Dr. Halil Z. Alibaba**

## COURSE OUTLINE

<b>COURSE CODE</b>	ARCH246	<b>COURSE LEVEL</b>	FALL / 2019-2020
<b>COURSE TITLE</b>	<b>Energy and Environmental Issues In Design</b>		
<b>COURSE TYPE</b>			
<b>LECTURER(S)</b>	Assoc. Prof. Dr. Halil Z. Alibaba Office-Architecture Bldg., Rm.023 halil.alibaba@emu.edu.tr Office Tel: 630 1142		
<b>CREDIT VALUE</b>	(3+0+0) 3	<b>ECTS VALUE</b>	4
<b>PREREQUISITES</b>	None		
<b>COREQUISITES</b>	None		
<b>DURATION OF COURSE</b>	One semester (13 Weeks)		
<b>WEB LINK</b>			

### CATALOGUE DESCRIPTION

A course to study the environmental factors influencing architectural design. Issues of climate, lighting and acoustics in relation to energy problems and user comfort. Climatic elements, classification of climates for architectural purposes, thermal process of human body, thermal comfort indexes, thermal process of buildings. Various climate control methods in buildings: thermal, solar, condensation, wind control and natural ventilation.

### AIMS & OBJECTIVES

A course to study the environmental factors influencing architectural design. Issues of climate, lighting and acoustics in relation to energy problems and user comfort. Climatic elements, classification of climates for architectural purposes, thermal process of human body, thermal comfort indexes, thermal process of buildings. Various climate control methods in buildings: thermal, solar, condensation, wind control and natural ventilation.

### GENERAL LEARNING OUTCOMES (COMPETENCES)

On successful completion of this course, all students will have developed **knowledge** and **understanding** of:

- energy and environmental issues,
- climate on macro and micro scale,
- thermal process of human body and thermal comfort,
- thermal process of buildings.

On successful completion of this course, all students will have developed **their skills in**:

- designing energy conscious buildings by controlling the climatic parameters,
- designing passive solar systems when needed,
- designing condensation free buildings,
- controlling sunshine, natural ventilation and wind in and around buildings.

On successful completion of this course, all students will have developed their appreciation of and respect for **values and attitudes** regarding the issues of: energy consciousness in architecture.

### GRADING CRITERIA

Letter grading system is based on ranking the students according to their success in class. The students will be graded in terms of class average(**M**) and standard deviation(**SD**) of number grades, according to the following formulas. Only the lower limits of each letter grade are given below.

A	= M + 2 SD
A –	= M + 1.6 S
B+	= M + 1.3
B	= M + 1 SD
B –	= M + 0.7 SD
C+	= M + 0.35 SD
C	= M
C –	= M – 0.30 SD
D+	= M – 0.6 SD
D	= M – SD
D –	= M – 1.3 SD
F	= 0

### **RELATIONSHIP WITH OTHER COURSES**

It is very much related to all the Design Studio courses because the skills obtained here will be used in them as well.

### **LEARNING / TEACHING METHOD**

There will be regular lectures, problem solving applications, short quizzes. The lecture notes can be purchased at the beginning of the semester. They are also available on the web. Lecture notes will be projected to a screen. During the lecture and the students will be encouraged to ask questions and contribute to the discussions.

### **ASSIGNMENTS**

Study of various climatic control elements by other architects and present them in class.

### **METHOD OF ASSESSMENT**

(30% of the quizzes average + 30% of the midterm exam + 40% of the final exam) will make the final grade of the student.

### **ATTENDANCE**

According to the university regulations students should attend at last 80% of the total lectures. Attendance will be taken at random times during the lecture hours.

### **TEXTBOOK/S**

None

### **INDICATIVE BASIC READING LIST**

- BROWN, G.Z., DEKAY, M., Sun, Wind & Light, Architectural Design Strategies. Second Edition. New York: John Wiley & Sons, Inc., 2001. ISBN 047134775.
- GALLO,C., Architecture: Comfort and Energy. New York: Elsevier Science, 1998. (EMU Library Catalogue No: 720.47 ARC, 1998 C.1.)
- GIVONI, B., Climate Considerations in Building and Urban Design. New York: Van Nostrand Reinhold, 1998. (EMU Library Catalogue No: 720.47 GIV, 1998.)
- OLGYAY, V. Design with climate. 2nd Edition. New Jersey: Princeton University Press,1963.
- OZDENIZ, M.B., Yapı Tasarımı İçin Türkiye İklim Verileri. Trabzon: 1984. (EMU Library Catalogue No: 721.046 OZD, 1984.)
- OZDENIZ, M.B., Mimari Yapıda Isı ve Yoğuşma Denetimi. Trabzon: TMMOB Mimarlar Odası Trabzon Şubesi Yayını,1987.(EMU Library Catalogue No:720.472 OZD,1987)
- SZOKOLAY, S.V., Environmental Science Handbook. Lancaster: The Construction Press, 1980.
- THOMAS, R., Environmental Design: An Introduction For Architects and Engineers. New York: E & FN Spon,1996. (EMU Library Catalogue No: 711 ENV, 1996.)
- WATSON, D., Climatic Design: Energy Efficient Building Principles and Practices. New York: McGraw-Hill, 1983.(EMU Library Catalogue No: 697.9 WAT, 1983.)

## EXTENDED READING LIST

- ANDERSON, B., *Solar Building Architecture*. Cambridge: MIT Press, 1990.  
(EMU Library Catalogue No: 720.472 SOL, 1990.)
- BALCOMB, J.D., *Passive Solar Buildings*. Cambridge: MIT Press, 1992.  
(EMU Library Catalogue No: 697.78 PAS, 1992.)
- BOURGES, B., *Climatic Data Handbook for Europe*. Boston: Kluwer Academic Publishers, 1992. (EMU Library Catalogue No: REF 551.527, CLI, 1992 C.1.)
- C.E.C., *Solar Architecture In Europe*. Bridport: Commission of European Communities, 1991. (EMU Library Catalogue No: 720.472 SOL, 1991.)
- IPCC *Climate Change 1995: The Science of Climate Change*, (Eds J. T. Houghton, L. G. M. Filho, B. A. Callander, N. Harris, A. Kattenberg, and K. Maskell) Cambridge University Press, Cambridge, UK. 1996.
- IPCC *The Regional Impacts of Climate Change: An Assessment of Vulnerability*, (Eds RT Watson, MC Zinyowera, RH Moss), Cambridge University Press, Cambridge, UK., 1998.
- IPCC *Climate Change 2001: The Scientific Basis*, Cambridge University Press, Cambridge, UK. , 2001.
- I.E.A., *Solar Low Energy Houses of IEA*. London: Science Publishers, 1995  
(EMU Library Catalogue No: 333.7923 SOL, 1995.)
- KELEŞ, M. Evaluation of mass housing of Northern Cyprus in respect to climatic design. Master's Thesis. Eastern Mediterranean University, Department of Architecture, Gazimağusa, 1998.
- LECHNER, N., *Heating, Cooling, Lighting: Design Methods for Architects*. New York: Wiley, 1991. (EMU Library Catalogue No: 697 LEC, 1991.)
- NOAA., <http://www.ncdc.noaa.gov/oa/climate/globalwarming.html> Global Warming, Frequently Asked Questions. National Oceanic and Atmospheric Administration web site.
- PALZ, W. *Solar Energy Applications to Buildings and Solar Radiation Data*. Dordrecht: Kluwer Academic Publishers, 1988. (EMU Library Catalogue No: 697.78 SOL, 1988.)
- PANCK, K., *Solar Interiors: Energy Efficient Spaces Designed for Comfort*. New York: Van Nostrand Reinhold, 1984. (EMU Library Catalogue No: 747.886 PAN, 1984.)
- SAYMANLIER, A., *Climatic Aspects of Spaces in Cypriot Vernacular Architecture*. M. Arch. Thesis. Gazimağusa: Eastern Mediterranean University, Faculty of Architecture, January 2001.
- SZOKOLAY, S. V., *Introduction to Architectural Science: The Basis of Sustainable Design*. Oxford: Architectural Press, 2004. (EMU Library Catalogue No: 721 SZO, 2004)
- THOMAS, R., *Environmental Design: An Introduction For Architects and Engineers*. New York: E & FN Spon, 1996. (EMU Library Catalogue No: 711 ENV, 1996.)
- UCS., <http://www.climatehotmap.org/index> Global Warming: Early Warning Signs. The Union of Concerned Scientists web site.
- WHITE, I.D., *Environmental Systems*. London: Chapman & Hall, 1992.  
(EMU Library Catalogue No: 551.6 WHI, 1992.)

## SEMESTER OFFERRED

2019-2020 Fall Semester



## CONTENT & SCHEDULE

Arch 246 lectures will be held on Tuesday Gr: 01 (08:30-11:20 am) in S05 and Wednesday Gr:02 (08:30 – 11.20 am) in S04.

The lecture topics were given in the following schedule:

WEEK	DATE	TOPICS
1	24-25 Sept 2019	Introduction to the course.
2	01-02 Oct. 2019	Energy issues in the world and its relation to architecture.
3	08-09 Oct. 2019	Definition of climate, climatic elements. The ways climatic elements effect architectural design.
4	15-16 Oct. 2019	Climatic deviations due to topography and the other site conditions. Classification of climates for architectural purposes. Presentation of the climatic data in graphical form.
5	22-23 Oct. 2019	Thermal process of human body. Sensation of thermal comfort. Thermal comfort indices.
6	30 Oct. 2019	Thermal and condensation control in buildings. Thermal process of buildings. Thermal control in buildings.
7	05-06 Nov. 2019	Thermal process of buildings. Thermal control in buildings.
7	11-14 Nov. 2019	<b>Mid-Term Jury Week</b>
8	18-21 Nov. 2019	<b>Mid-Term Exam Week</b>
9	26-27 Nov. 2019	Introduction to Sun Control and Shading device design.
10	03-04 Dec. 2019	Sun Control. Shading device design.- Holiday
11	10-11 Dec. 2019	Room Acoustics (Acoustic shadow, Sound level, Outdoor sound control, Reverbation time, Auditoriums for speech)
12	17-18 Dec. 2019	Room Acoustics (Acoustic shadow, Sound level, Outdoor sound control, Reverbation time, Auditoriums for speech)
13	24 Dec. 2019	Room Acoustics (Auditoriums for music-Multipurpose) Revisions
14	31 Dec. 2019	Course Revisions
15	06-10 Jan. 2020	<b>Final Jury Week</b>
16	20 -24 Jan. 2020	<b>Final Exams Week</b>

### PLAGIARISM

This is intentionally failing to give credit to sources used in writing regardless of whether they are published or unpublished. Plagiarism (which also includes any kind of cheating in exams) is a disciplinary offence and will be dealt with accordingly.)

**COME TO THE LECTURES IN TIME. ASK QUESTIONS ANY TIME DURING THE LECTURES.**

## 1. INTRODUCTION TO ENVIRONMENTAL CONTROL 1

Aim of the course:

One of our duties as architects, is to provide comfortable internal spaces. We do this by controlling physical environmental conditions.

What is environment?

- (A simple definition.) Environment is all around us.
- (A more scientific definition.) Environment is the stimulus field to which men respond in some way.

Physical Environment deals with the relations of human beings with the following factors:

- Heat
  - Humidity
  - Wind
  - Radiation
- etc. (The first four factors can be summarised as CLIMATE.)
- Sound
  - Light
- etc.

Climatic conditions can be controlled in two ways:

1. By the use of energy.  
(This is also called as “artificial” or “mechanical” control)

Energy is scarce. It is getting more and more expensive everyday.

Energy is needed both for industrial production and for keeping the buildings comfortable.

All the countries do not produce all the energy they need.

e.g. Turkey produces less than 50 % of the energy she uses.

In average a developing country uses one-third of her overall energy to heat, cool and light buildings.

In our days energy is produced from:

- . Fossil fuels (petroleum, natural gas, coal),
- . Hydropower,
- . Organic material,
- . Wind, solar and tidal power,
- . Nuclear power.

Fossil fuels are not endless. One day they will end. Nuclear energy has environmental risks.

2. By the use of natural means.  
(This is also called as “structural” control)
  - By the suitable selection of site, orientation, building materials and building forms.

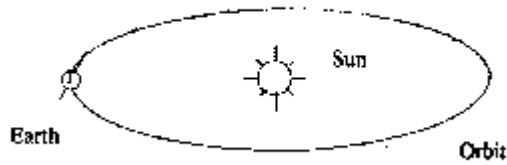
CLIMATE is the long-term averages of physical states of atmospheric conditions at a geographical location.

WEATHER is the momentary physical state of atmospheric conditions at a certain location.

On the earth there are lots of climates.

What generates these climates?

Figure 1. The earth's orbit around the sun.



The sun is the dominating influence on climates.

The earth receives almost all of its energy from the sun.

The amount of solar energy received on earth's surface is not equal.

Solar constant = 1395 W/m<sup>2</sup>

This is the solar radiation received by a perpendicular surface outside the atmosphere.

What are the reasons of receiving different amount of radiation on earth?

Tilt of the earth's rotational axis.

Angle of incidence.

Solar altitude angle.

Atmospheric depletion: Absorption of radiation by ozone, water vapour, dust particles, etc. Absorption of radiation is more if the distance travelled in the atmosphere is more.

Figure 2. The earth-sun relationship.

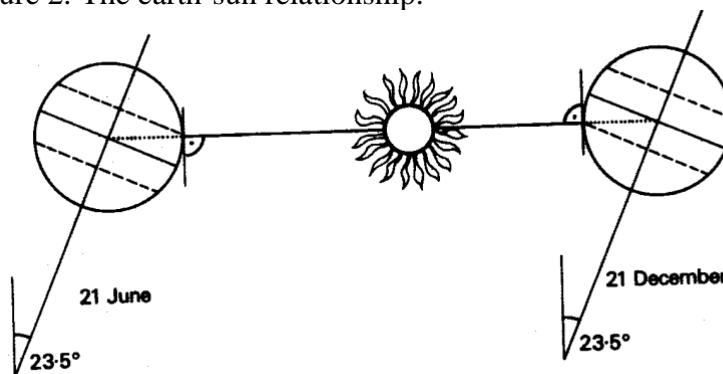


Figure 3. Explanation of the angle of incidence ( $\beta$ ) and the cosine law.

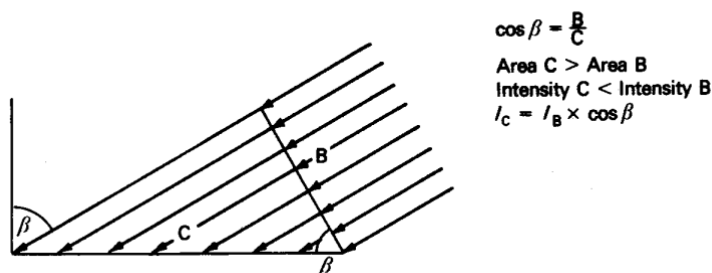


Figure 4. Solar filtering due to the length of path through the atmosphere.

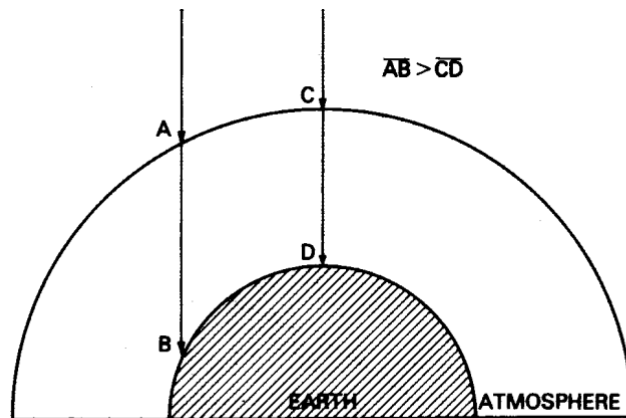
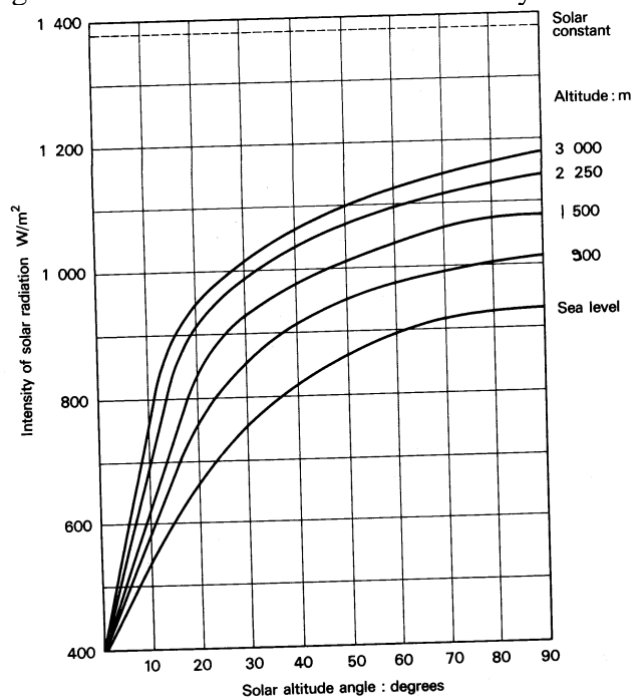


Figure 5. Variation of direct solar intensity with height above sea level.



**ALL PARTS OF THE EARTH RECEIVE DIFFERENT AMOUNT OF SOLAR ENERGY.**

At the parts of the earth, which receive more solar radiation, air temperatures rise and the air starts to rise. The air from the cooler parts of the earth comes to the warm areas and thus winds are generated. Some winds pass over oceans thus they become moist. Some pass over the inlands or high mountains and loose their moisture. Thus different types of climates are generated.

**INTER TROPICAL CONVERGENCE ZONE:** The part of the earth, which receives the most solar energy.

- Annual predominant winds
- Influence of topography

Figure 6. Seasonal movement of inter-tropical convergence zone.

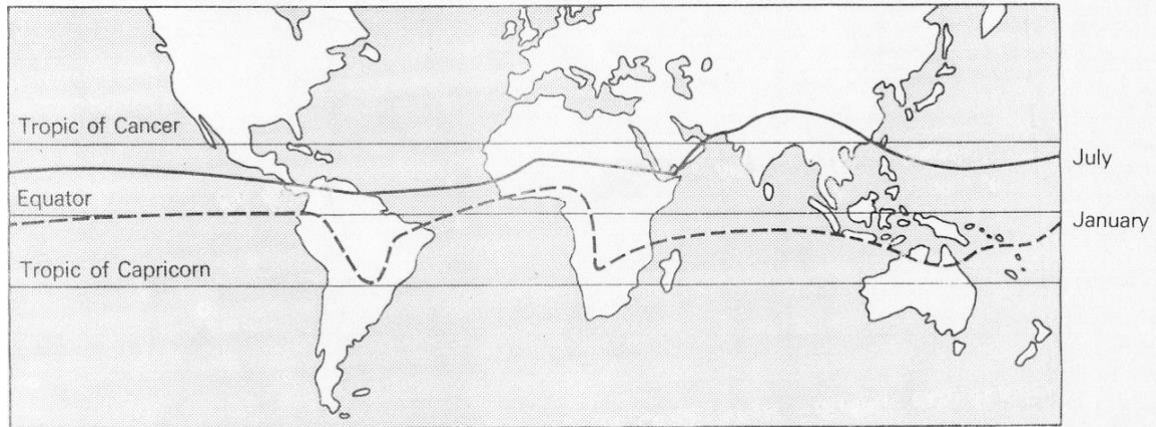
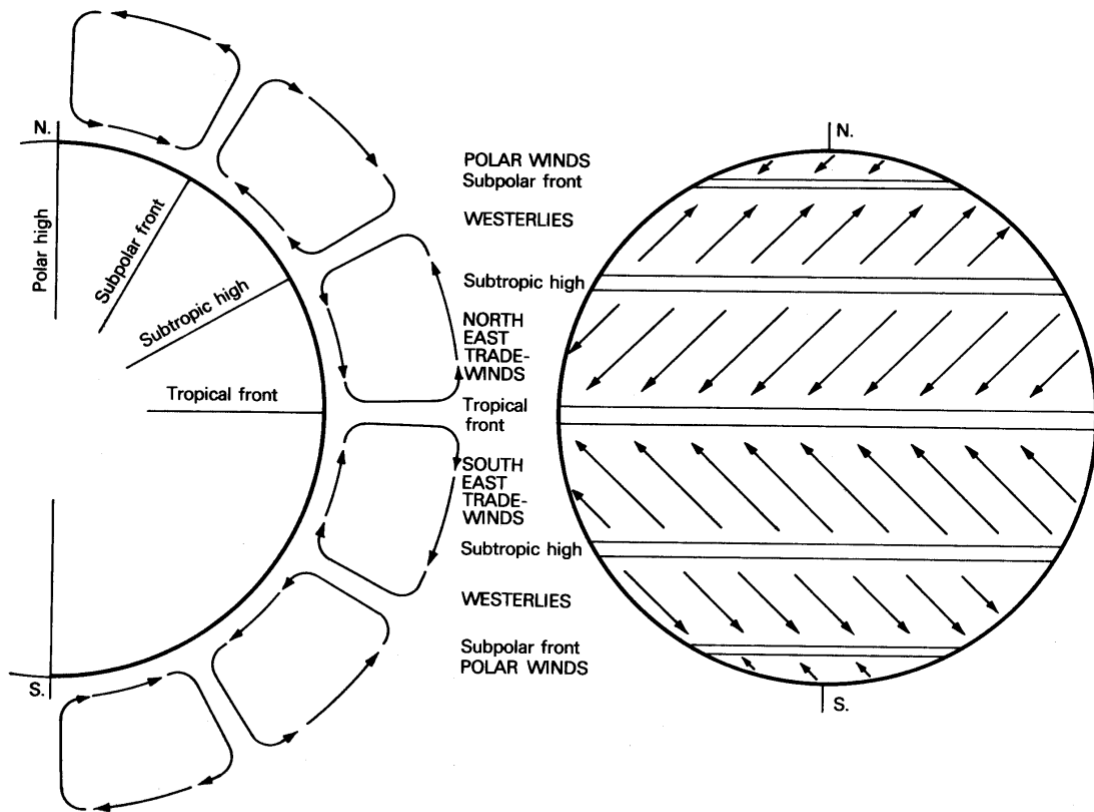


Figure 7. Predominant global winds.



TYPES OF CLIMATE. Although there are thousands of climates on the earth we can classify them for architectural purposes.

- Cool climate (1)
- Temperate dry (2), temperate (3), temperate humid (4) climates
- Hot dry climate (arid) 5
- Hot humid climate (6)
- Composite climate (7).

## 2. CLIMATIC ELEMENTS

Climatic elements are the physical factors like air temperature, humidity, precipitation, wind, solar radiation, sky conditions (cloud cover, sunshine period, days with open and closed sky) with which identify the climate.

### AIR TEMPERATURE

°C Degrees Celsius

K Kelvin Degrees

Mercury Thermometer

Dry Bulb Thermometer

Stevenson Screen

DATA Monthly Mean Maximum Temperature

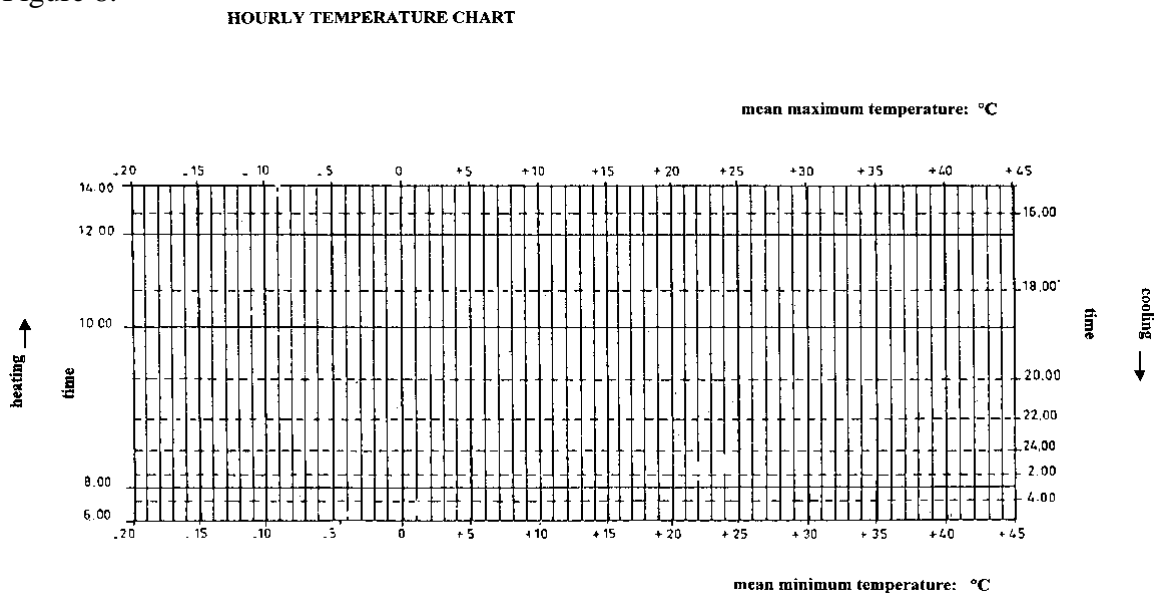
Monthly Mean Minimum Temperature

Hourly Temperature Chart

Deviations

Relation to architectural design.

Figure 8.



## HUMIDITY

Hygrometer

Wet and dry bulb hygrometer

Absolute Humidity (A.H.) g/kg

Saturation-point Humidity (S.H.) = (Dew-point Humidity g/kg

Relative Humidity (R.H.) %

$$\text{RH \%} = \frac{\text{AH}}{\text{SH}} \times 100$$

Vapour Pressure ( $P_v$ ) N/ m<sup>2</sup>

Atmospheric Pressure (P)=Pressure of dry air ( $P_a$ )+ Vapour Pressure ( $P_v$ )

Saturation-point Vapour Pressure ( $P_{sv}$ )

$$\text{RH \%} = \frac{(P_v)}{(P_{sv})} \times 100$$

Data . 07.00 Hours Relative Humidity

. 14.00 Hours Relative Humidity

Psychrometric Chart

Deviations

Relation with architecture

## PRECIPITATION (Rain, snow, hail, dew, frost)

Rain gauge mm/time unit (hour, day, month, year)

DATA . monthly precipitation mm/month

. average days with snow cover

. average snow densities

. average snow height

Deviation

Relation with architecture

90 mm/month or 600 mm/year

## DRIVING RAIN (DR) (Wind driven rain)

$$\text{DR} = \text{R} \frac{V_{\text{wind}}}{V_{\text{terminal}}}$$

Driving rain index = Annual Rainfall (m) x Annual Mean Wind Velocity m/s

0 ~ 3 m<sup>2</sup>/s Sheltered

3 ~ 7 m<sup>2</sup>/s Moderate

Over 7 m<sup>2</sup>/s Severe

## WIND

Anemometer

(Cup type anemometer)

Measurement at 10 m above the ground.

Mean Hourly Wind Velocity

Mean Gust Velocity

Mean Severe Wind Direction

Mean No of Days with strong winds (10.8-17.1 m/s)

Wind Roses

#### Predominant Wind

Calm	0.0 - 0.2 m/s
Light wind	0.3 - 3.3 m/s
Moderate wind	3.4 - 7.9 m/s
Severe wind	$\geq$ 8.0 m/s

#### Deviations

Town centres

Height

Drainage winds

Tunnelling

Wind brakes – Reduction in wind velocity is 50% up to 10H, 25% up to 20H.

#### Relation with architecture

- Required and unwanted winds
- Wind roses with ET curves.
- Settlements near industrial zones.
- Smoke chimneys.

Figure 9.



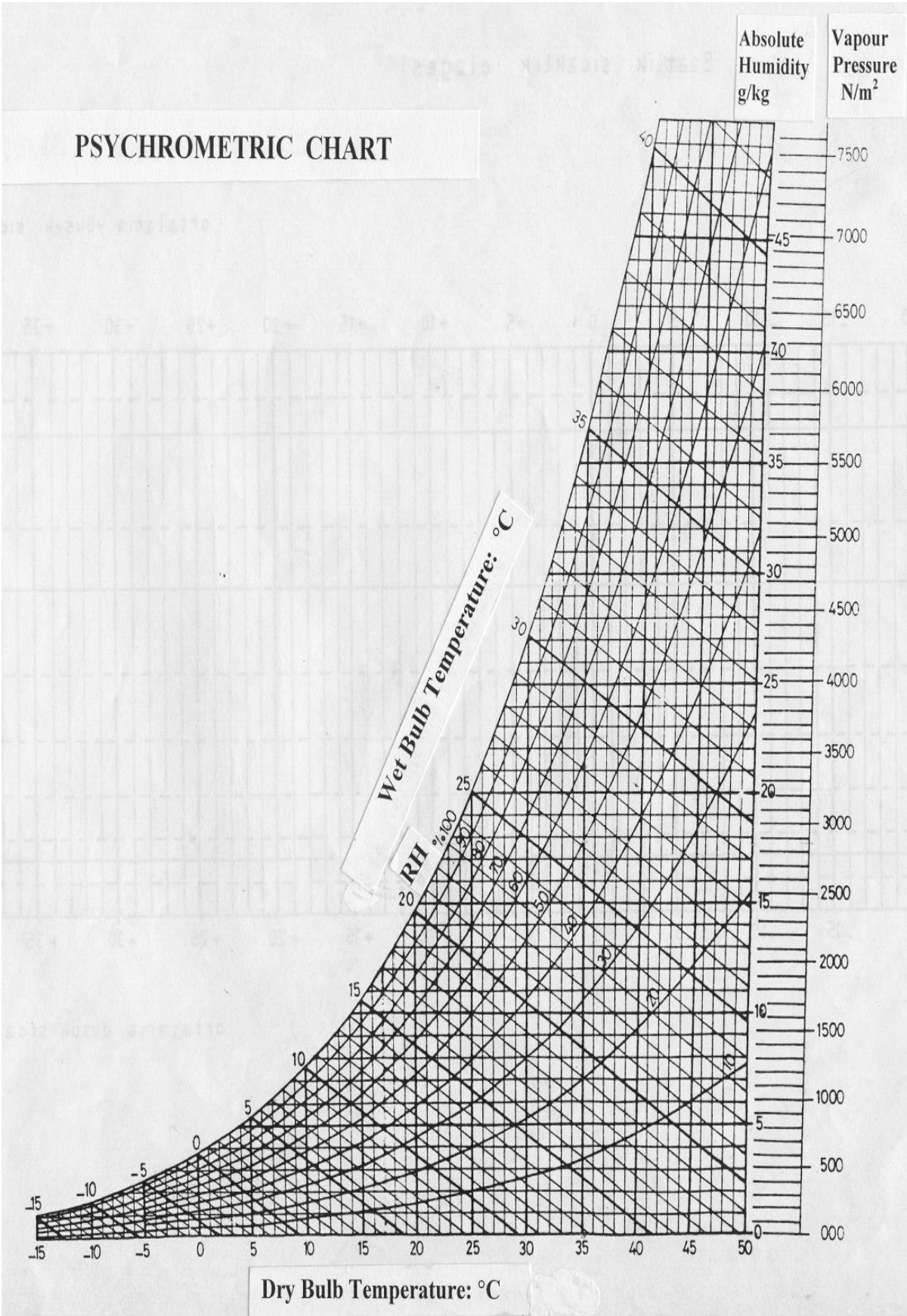
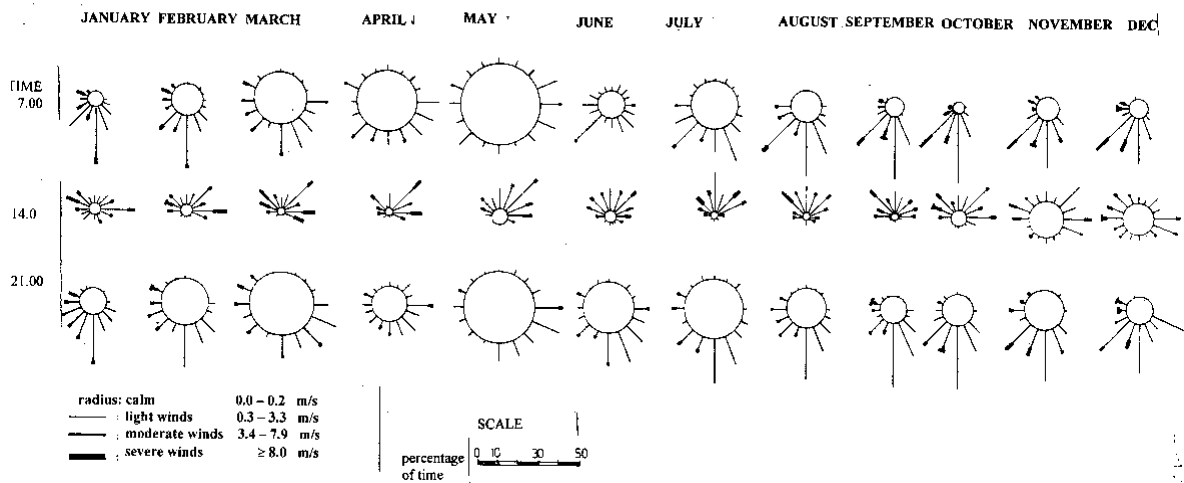


Figure 10.

### MONTHLY WIND ROSES OF TRABZON



### SOLAR RADIATION

“Solar intensity” is the solar energy flow on one square meter area.

$$W/m^2 = J/s \cdot m^2$$

Total amount of solar energy on a surface in a day is expressed as

$J/m^2 \text{ day}$  or  $MJ/m^2 \text{ day}$

Mega =  $10^6$  (1 million)

Watt-hour (Wh) = 1 joule of energy applied for one hour (3600 seconds)

Components of Solar Radiation

- Direct radiation
- Diffused radiation
- Reflected radiation

Data . Average Total Daily Solar Energy

. 24h Average of Radiation Intensity

. Solar angles

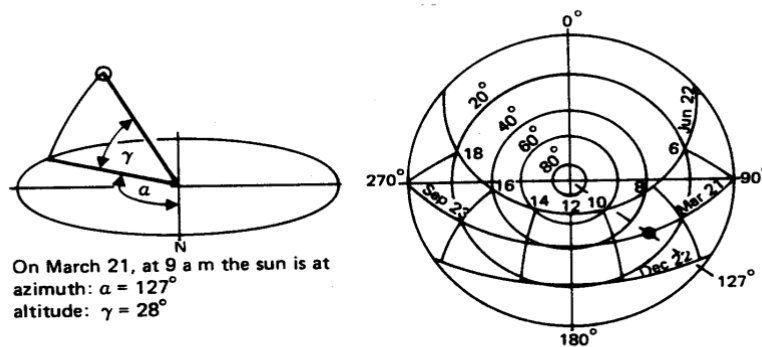
. Sun path diagrams

Stereographic Projection

Solar Altitude Angle ( $\gamma$ )

Solar Azimuth Angle ( $\alpha$ )

Figure 11. Solar altitude and azimuth angles,



## Deviations

- . Air pollution, clouds, water vapour
- . Slope and orientation of the site
- . Hills and mountains

## Relation with architecture

- . External building elements, materials
- . Solar shading devices
- . Window design

## **SKY CONDITIONS**

Cloud cover, sunshine period, days with open and close sky, no of days with fog are the climatic elements which are summarized as “sky conditions”.

Open sky (if cloudiness is between 0.0 – 1.9)

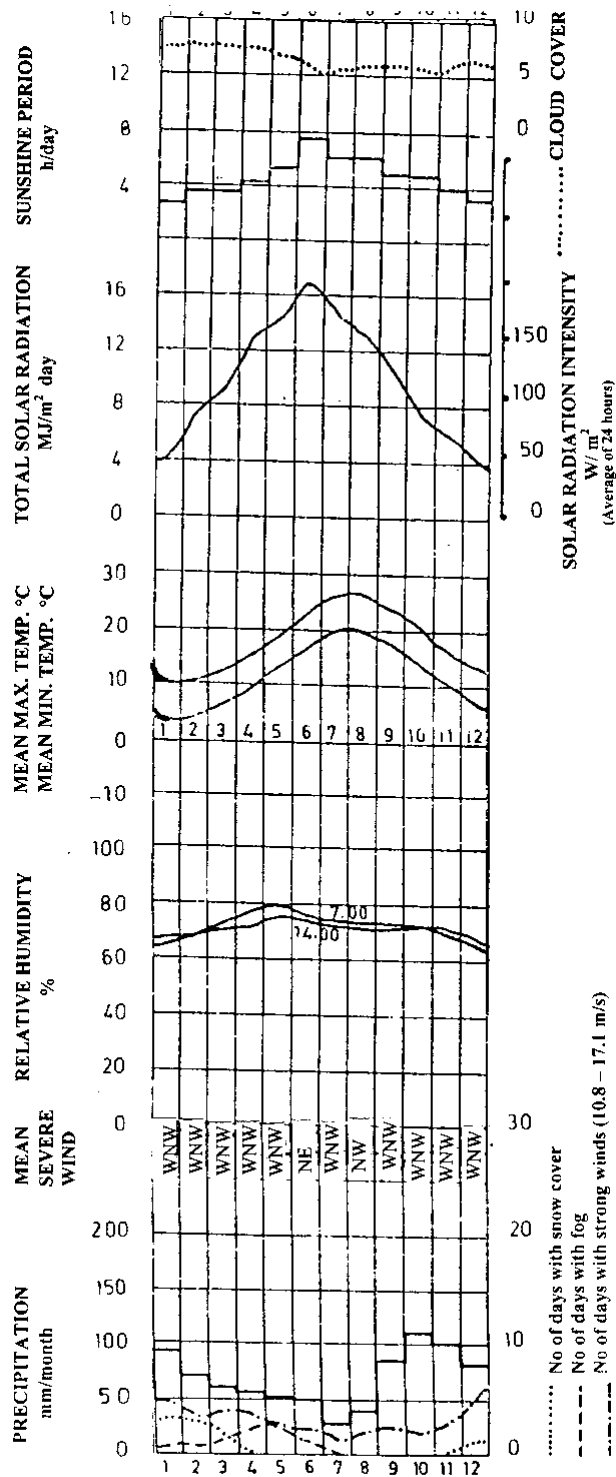
Cloudy sky (if cloudiness is between 2.0 – 8.0)

Closed sky (if cloudiness is between 8.1 – 10.0)

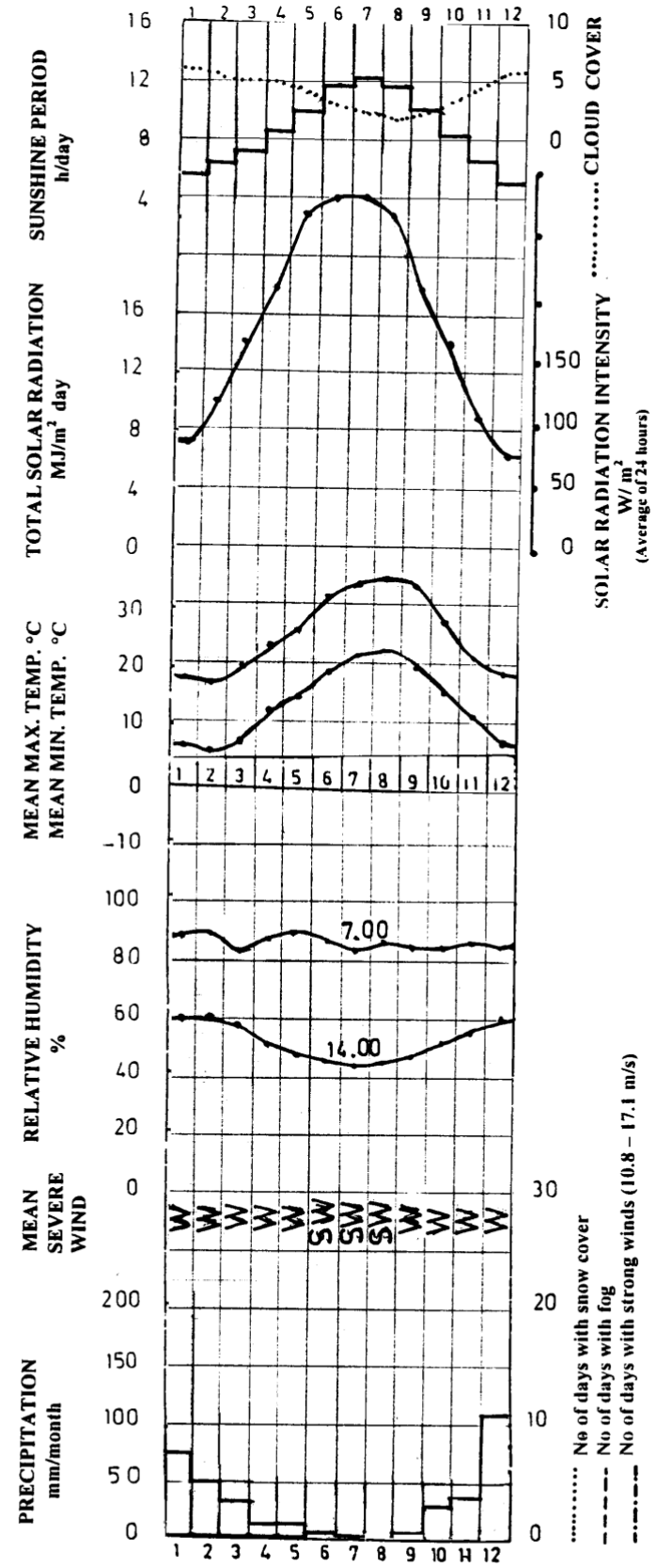
# PRESENTATION OF CLIMATIC DATA IN GRAPHIC FORM

## Meteorological Chart

Figure 12 Meteorological Charts of various towns.

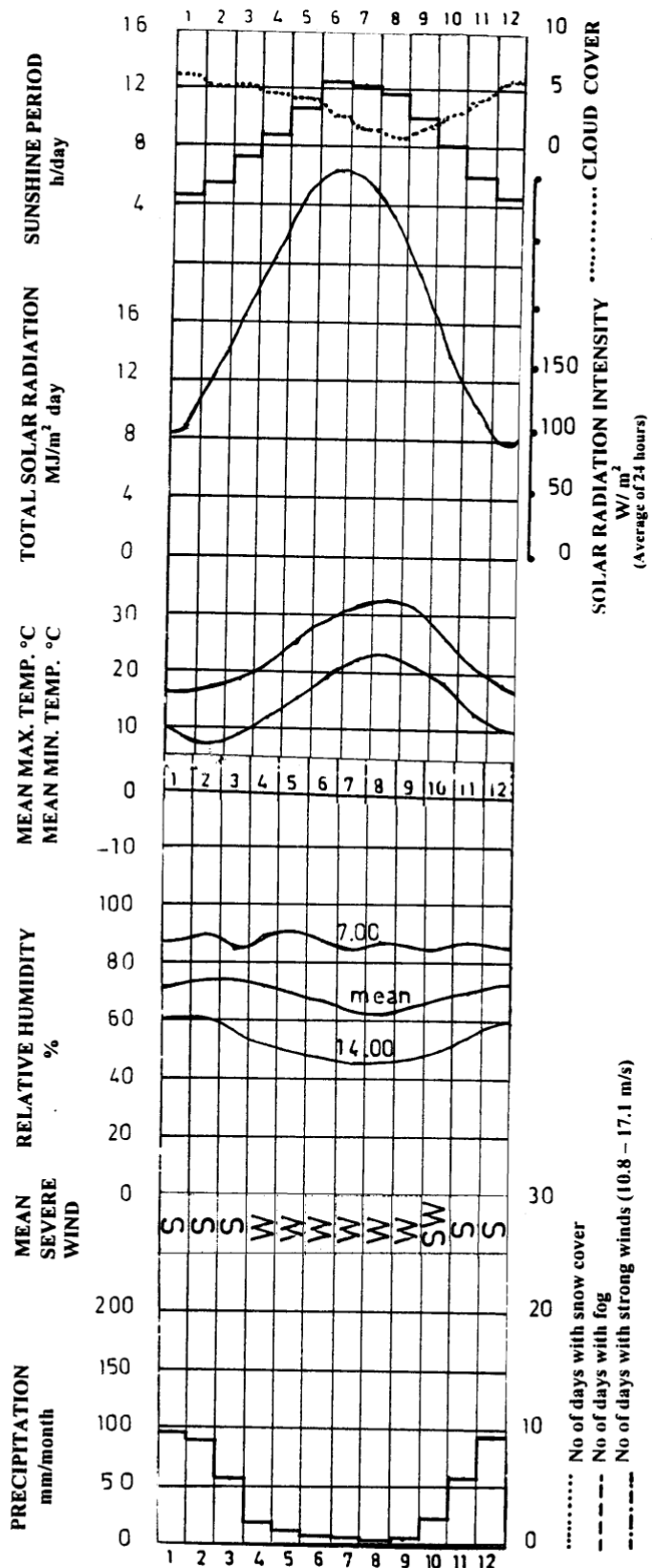


Observation Place : TRABZON  
 Location : 41° 00' N. 39° 43' E.  
 Elevation Above Sea Level : 30 m.



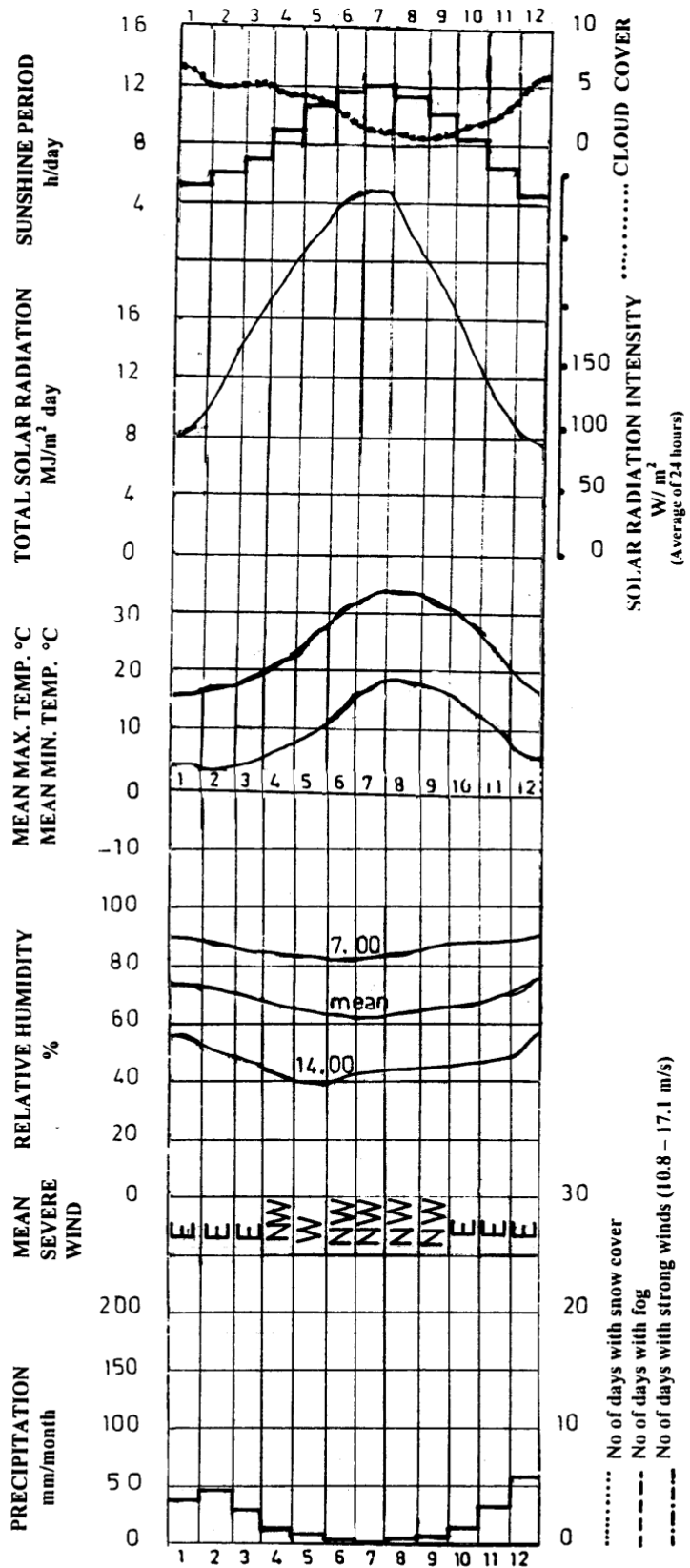
Observation Place : GAZIMAGUSA  
 Location : 35° N Latitude 34° E Longitude  
 Elevation Above Sea Level : 7 m.

Figure 12 (Continued).  
 Figure 12 (Continued).



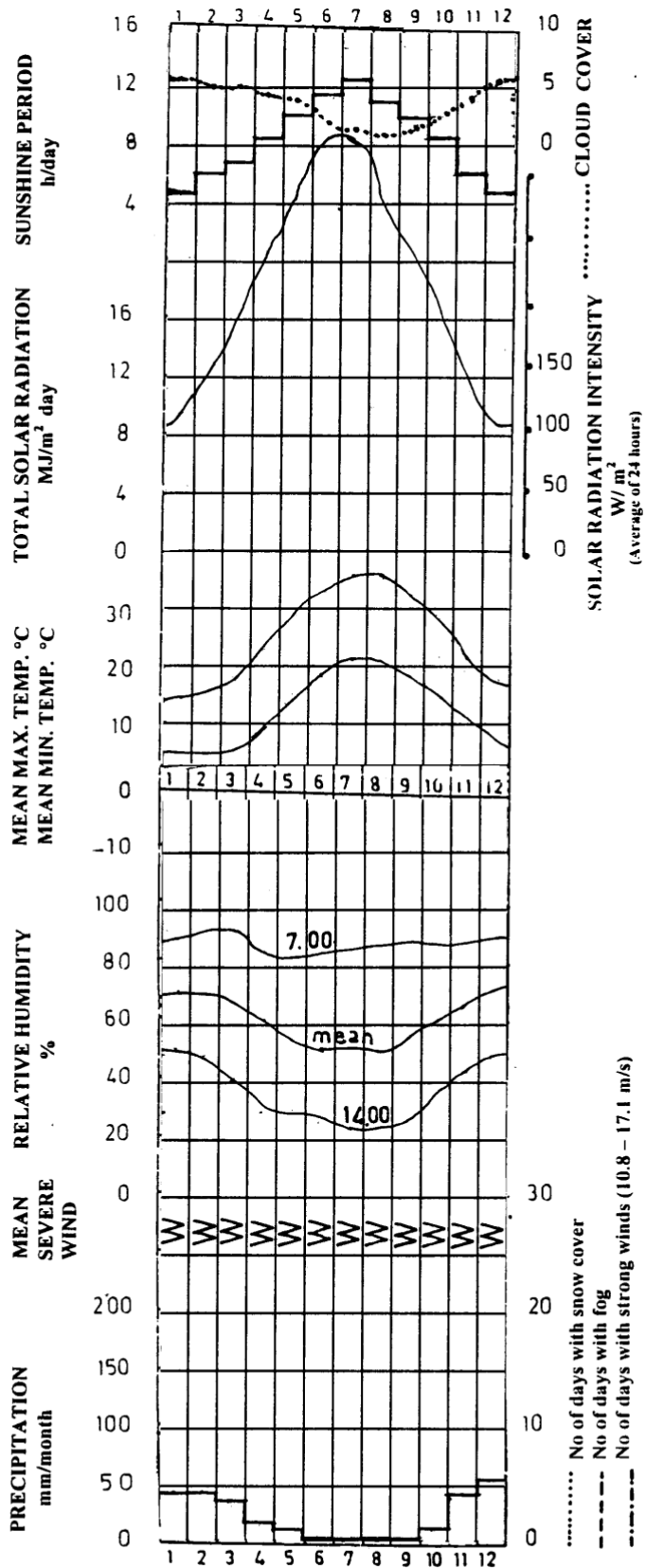
Observation Place : GIRNE  
 Location : 35.5° N Latitude 33.5° E Longitude  
 Elevation Above Sea Level :

Figure 12 (Continued)



**Observation Place** : GÜZELYURT  
**Location** : 35.3° N Latitude 33° E Longitude  
**Elevation Above Sea Level** :

.Figure 12 (Continued).



Observation Place : LEFKOŞA  
 Location : 35.2° N Latitude 33.5° E Longitude  
 Elevation Above Sea Level :

### 3. THE RELATION BETWEEN HUMAN BODY AND CLIMATE



The architects should know the relations between the human body and the environment as well as the physical environmental conditions.

What is the thermal process of the body?

What do we feel during this process?

When do we feel thermally comfortable?

How do we measure thermal comfort?

How can we classify the climates in terms of thermal comfort?

### THERMAL PROCESS OF HUMAN BODY

For the survival of a healthy person deep body temperature must be maintained at 37 °C . Deep body temperature may increase 1.5 °C during a heavy work. However, it stays at a narrow temperature interval.

Human body has to produce heat to maintain the 37 °C body temperature.

Body's heat production is called metabolism.

There are two types of metabolism.

- . Basal Metabolism – automatic heat production of the body.
- . Muscular Metabolism – heat production of muscles while doing work.

ACTION	METABOLIC RATE, W/ m <sup>2</sup>
Sleeping	41
Sitting	58
Slowly walking	116
Dancing	140-256
Heavy work	204-262

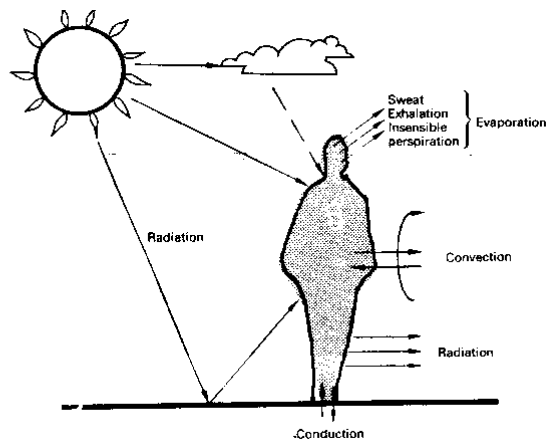
### Heat Transfer Between Human Body and Environment

Heat is transferred between human body and environment by four different ways. These are:

- . Convection
- . Conduction
- . Radiation
- . Evaporation

Figure 13.

Body heat exchange



Thermal balance of the body:

Metabolic Heat Production + Heat Gain = Heat Loss.

$$\text{Met} - \text{Evp} \pm \text{Cnd} \pm \text{Cnv} \pm \text{Rad} = 0$$

If the sum is more than zero, vasomotor adjustments will take place.

Enlarging of blood vessels.

Dilution of blood.

Increasing of skin temperature.

Sweating.

Increase of body temperature. (If body temperature rises above 40 °C heat stroke may develop. If the body temperature exceeds 42-43 °C for a long time some of the systems of the body do not function, may cause death.)

If the sum is less than zero, opposite vasomotor adjustments will take place.

Constriction of blood vessels.

Decreasing of skin temperature.

Shivering. (Production of heat at very short intervals.)

Decrease of body temperature. (Body temperature may decrease to 35 °C.

Death sets in at between 30 – 25 °C.)

### **SENSATION OF THERMAL CONDITIONS**

EXAMPLES: If we enter an unheated building in a cold windy day we feel warm. In front of a burning fireplace we may sometimes shiver. These examples indicate that it is not only air temperature which effects the thermal sensation. There are physical and subjective variables.

Physical variables on the sensation of thermal conditions:

Air temperature,

Air velocity,

Relative humidity,

Radiation.

Subjective (personal) variables on the sensation of thermal conditions:

Activity level,

Clothing,

Age,

Sex,

Diet

Shape of the body

Acclimatisation

### **THERMAL COMFORT**

- The condition in which a body achieves its thermal balance by using the least amount of energy.

- The condition of mind, which expresses satisfaction with thermal environment. (ASHRAE)

**THERMAL COMFORT INDEX** is a common measure of all the factors, which effect thermal comfort. There are mainly two types of thermal comfort indices.

- Graphical thermal comfort indices.

- Analytical thermal comfort indices.

BIOCLIMATIC CHART (Olgyay, 1963)

NEW BIOCLIMATIC CHART (Arens et al, 1981)  
EFFECTIVE TEMPERATURE (Houghton and Yaglou, 1923)

**BIOCLIMATIC CHART** has been devised experimentally by Olgyay in 1963. It was prepared for 1 clo dressing and for sedentary or light activities. It shows the effect of physical factors separately on thermal comfort.

- Comfort zone.
- Practical comfort zone.
- Summer and winter comfort zones.
- Shading line.
- Wind needed zone.
- Moisture needed zone.
- Solar radiation needed zone.

Figure 14.

**BIOCLIMATIC CHART**

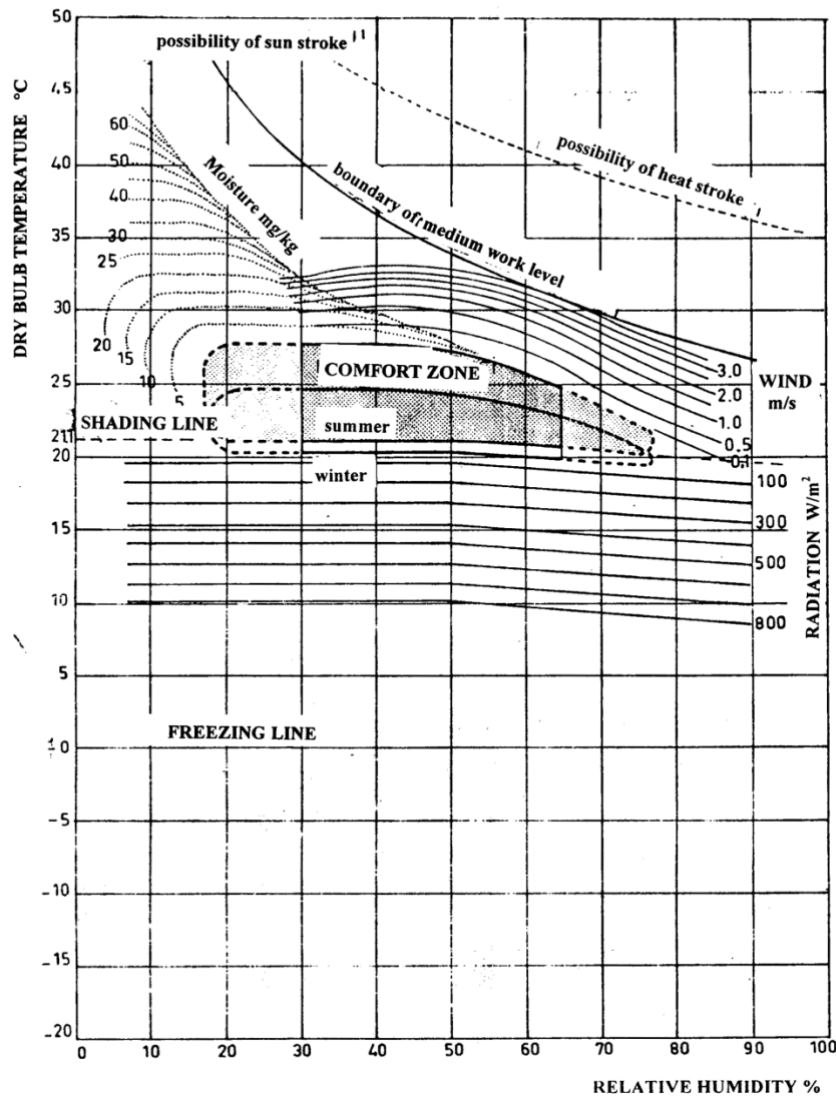
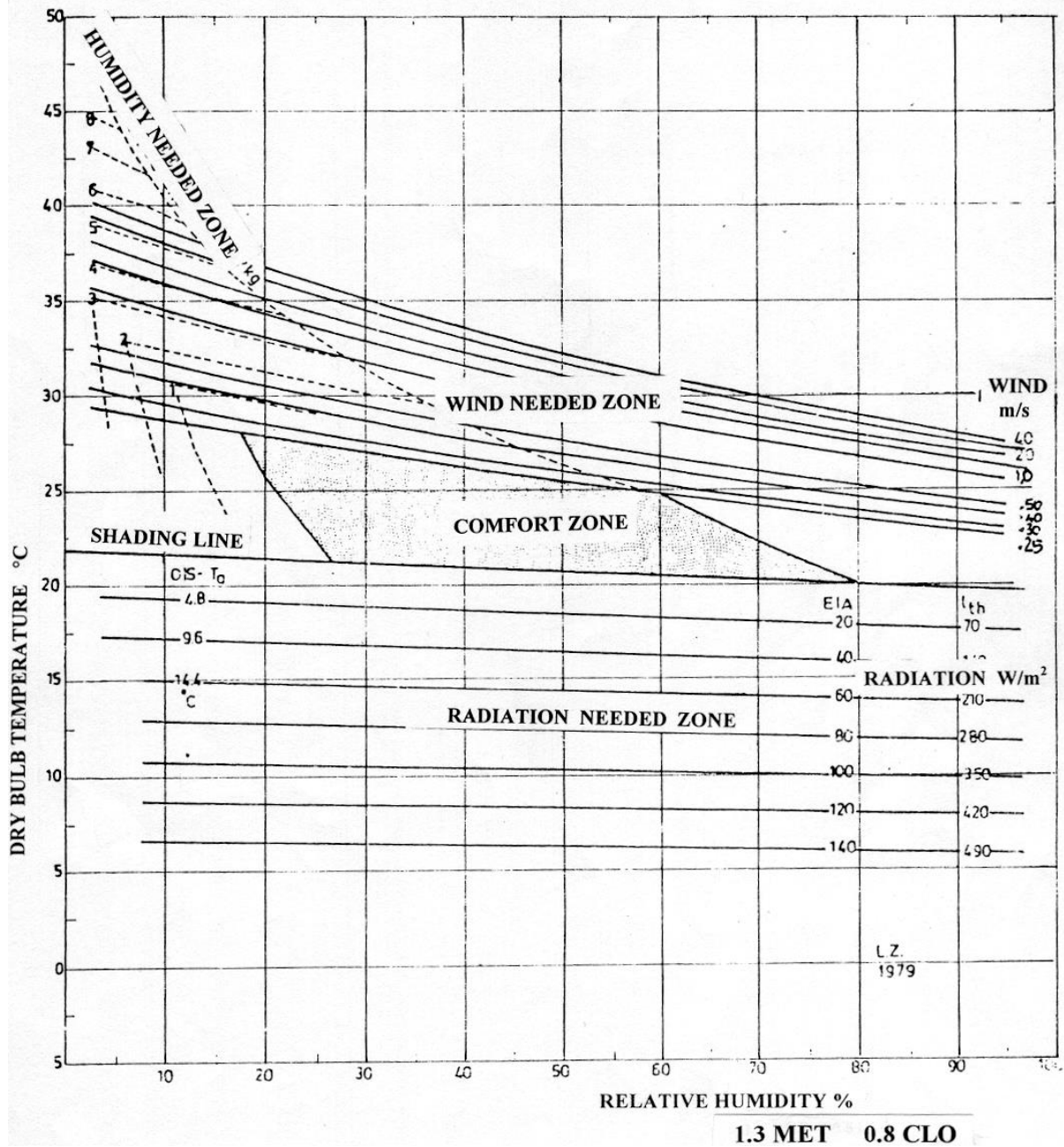


Figure 15

## THE NEW BIOCLIMATIC CHART



**NEW BIOCLIMATIC CHART** – has just one comfort zone for the whole year and it is better defined. We use it to identify the climate.

For each month:

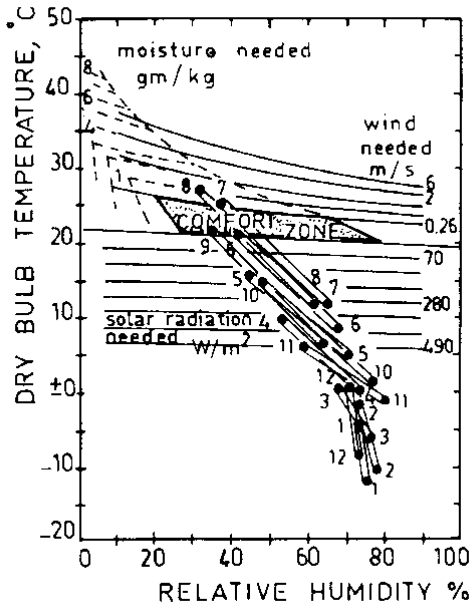
Mean Max. Air Temperature + 14.00 Hours Relative Humidity

Mean Min. Air Temperature + 7.00 Hours Relative Humidity

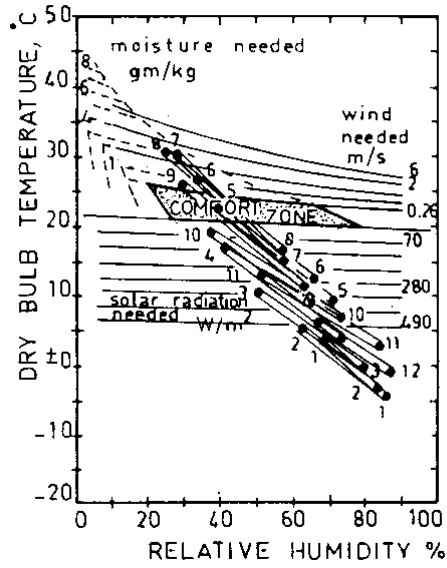
values are plotted. Then the distribution of the plots are observed.

Figure 16. Climatic data plotted new bioclimatic charts of various towns.

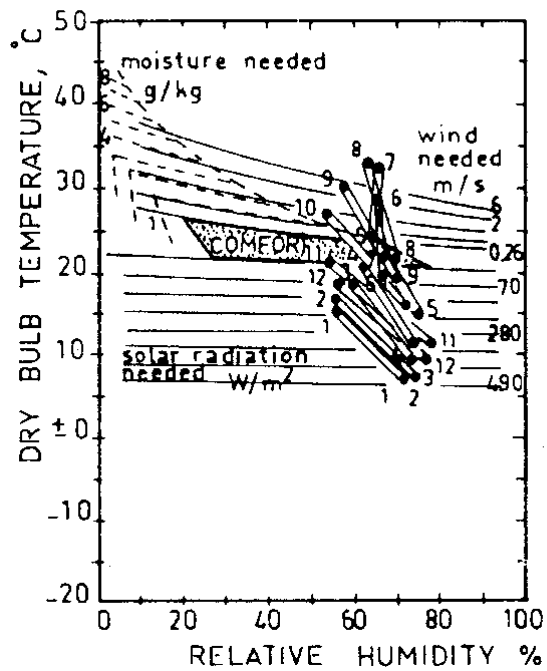
ERZURUM Cool



ANKARA Temperate-dry



ALANYA (Antalya) Hot-humid



DIYARBAKIR Hot-dry

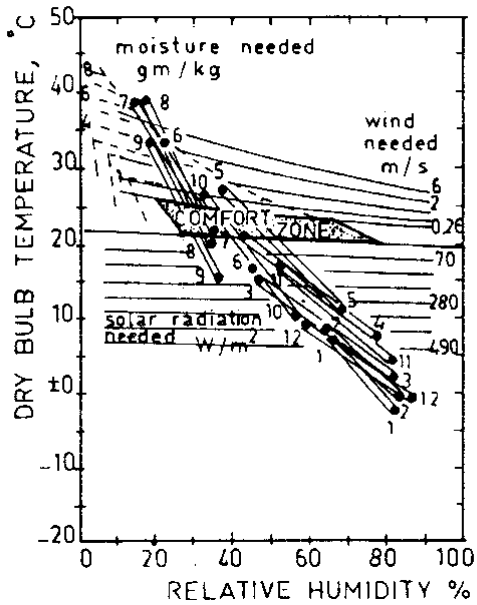
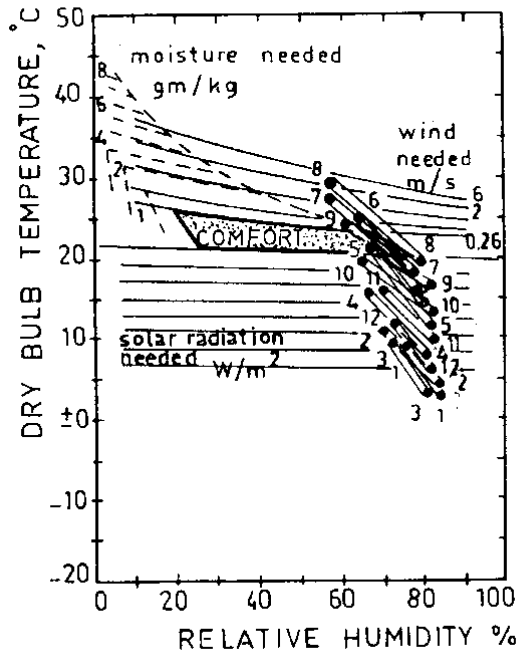
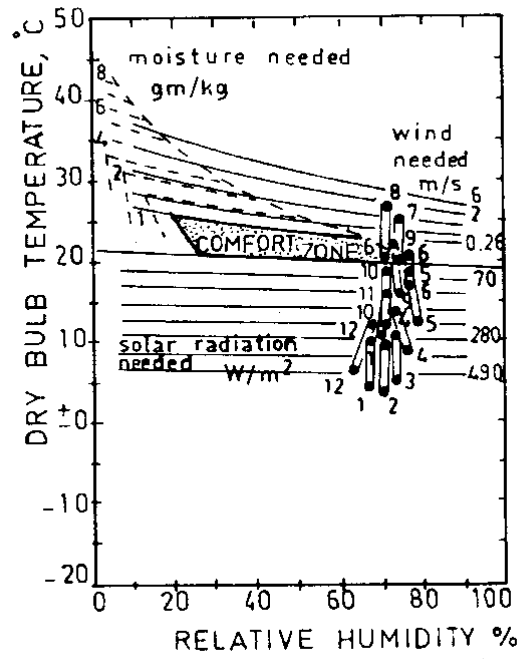


Figure 16 (Continued)

ISTANBUL Temperate



TRABZON Temperate-humid



AYDIN Composite

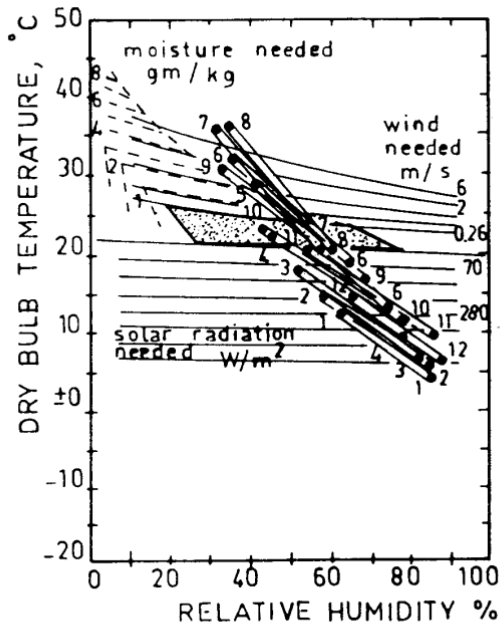


Figure 16 (Continued)

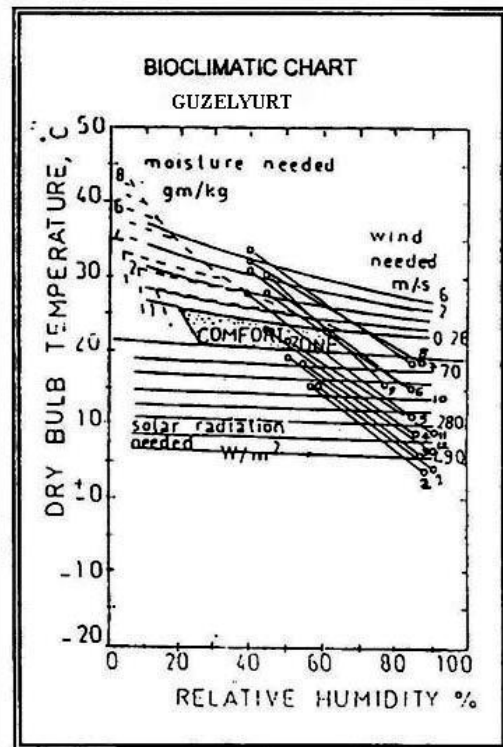
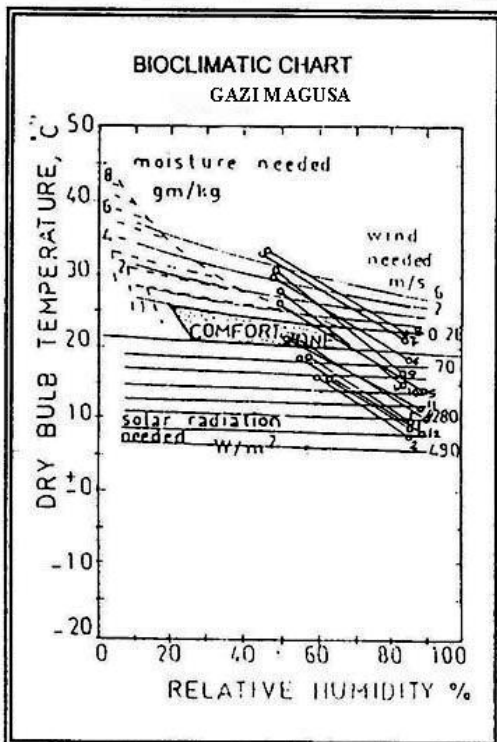
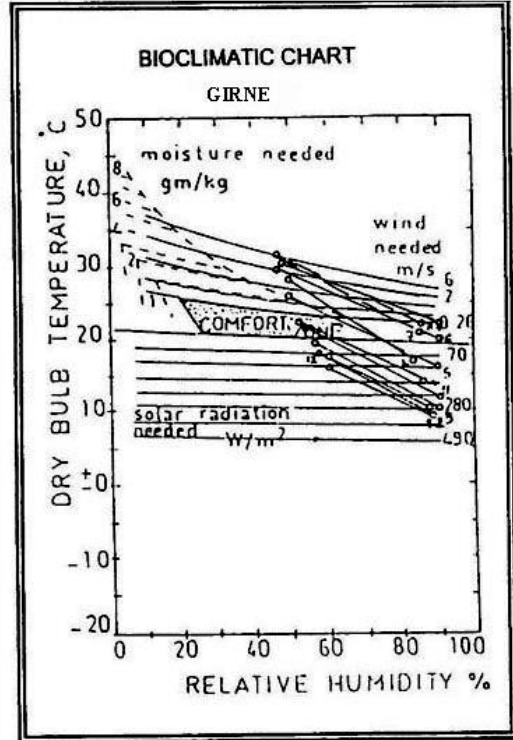
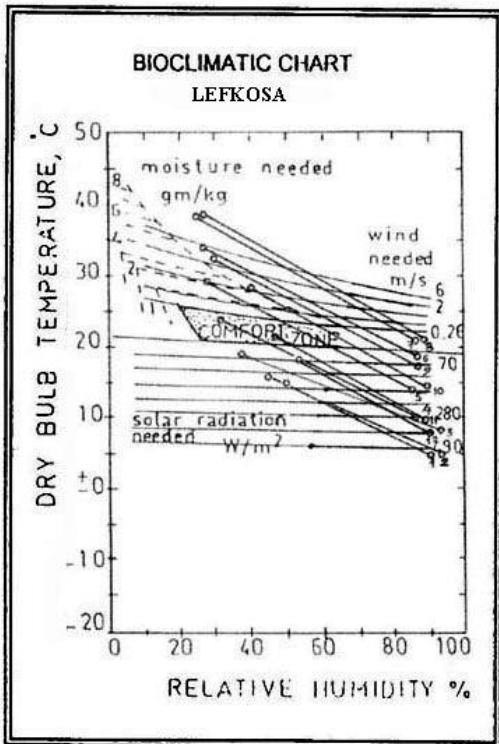
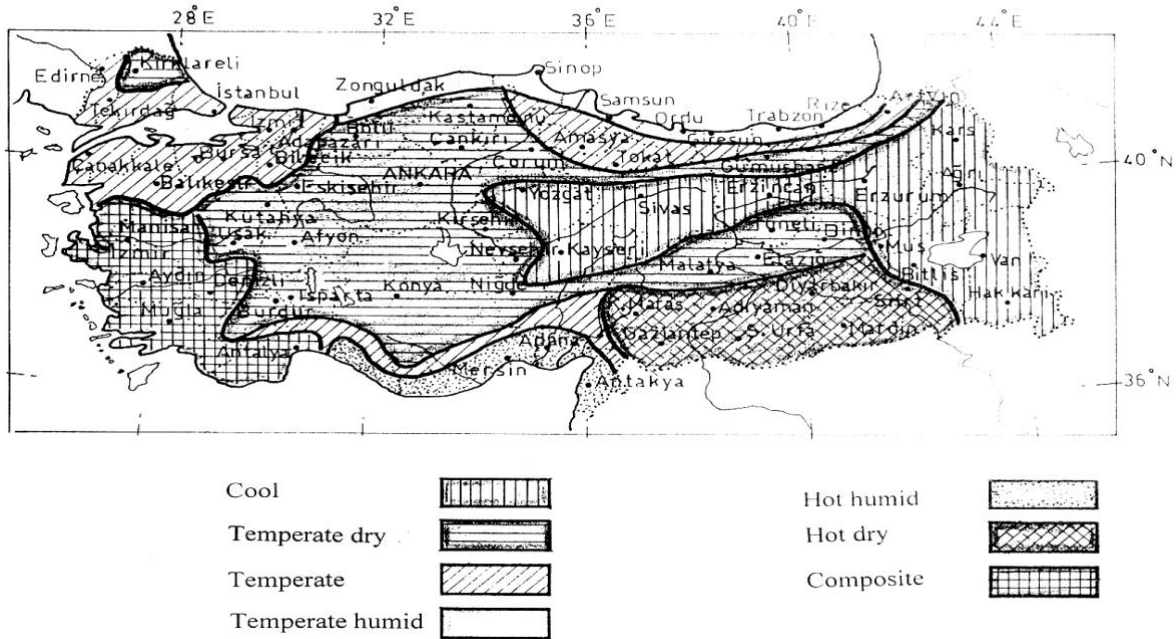




Figure 17.  
CLIMATIC MAP OF TURKEY



**EFFECTED TEMPERATURE CHART** has also been devised experimentally. There are two ET charts - one for normal business dressing and the other for half naked people. Both of them are for sedentary or light activities.

Unlike the Bioclimatic Chart, ET is an index that shows the combined effect of all physical factors on thermal comfort. For people living in Turkey and Cyprus, comfort zone is between 18 and 22.1 °ET.

We use ET to analyse the climate.

Figure 18.

**EFFECTIVE TEMPERATURE CHART  
FOR NORMALLY (1 clo) DRESSED PEOPLE**

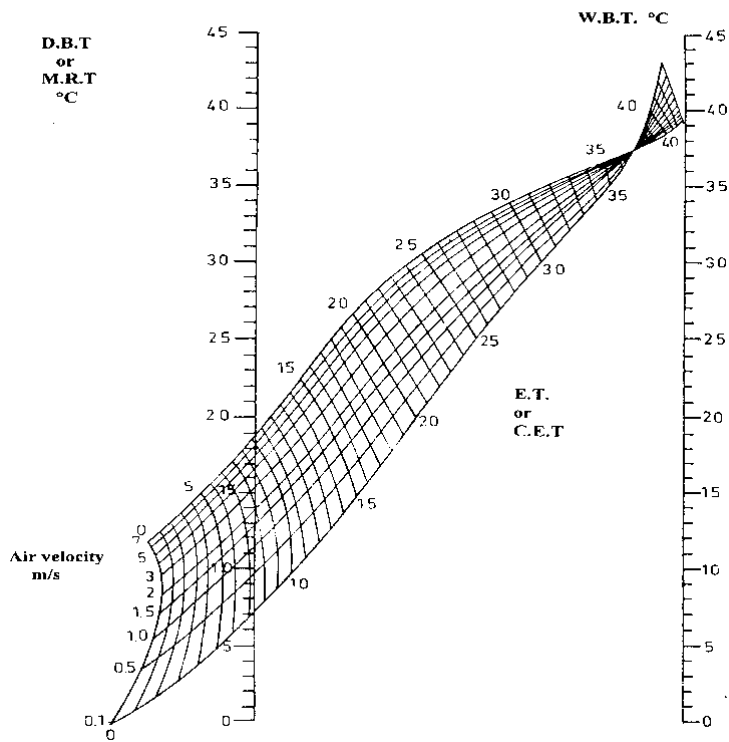


Figure 19.

**EFFECTIVE TEMPERATURE CHART  
FOR HALF NAKED PEOPLE**

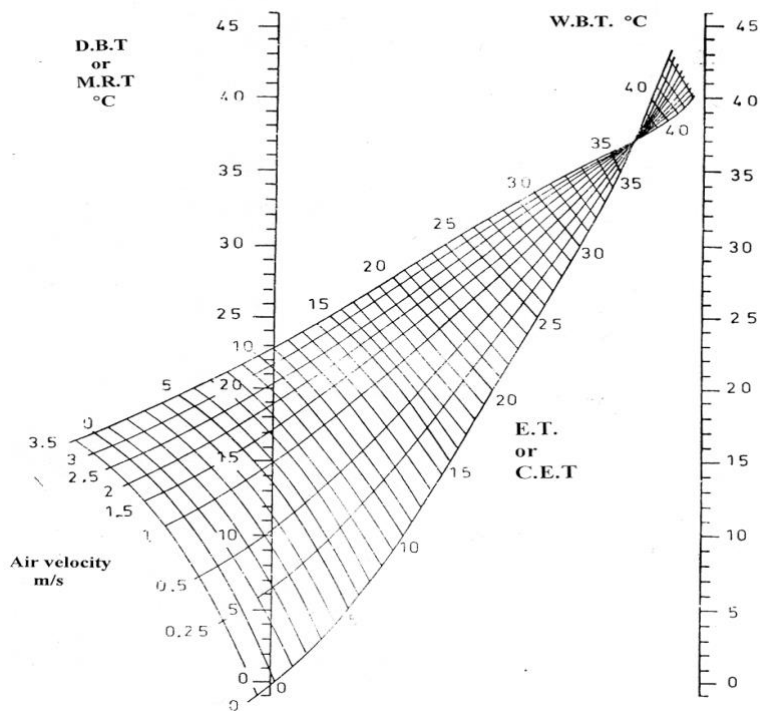
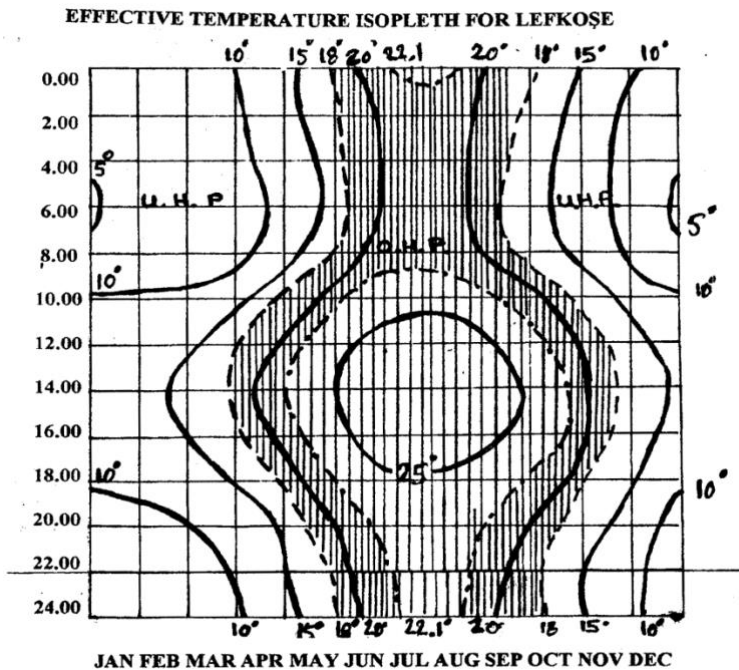
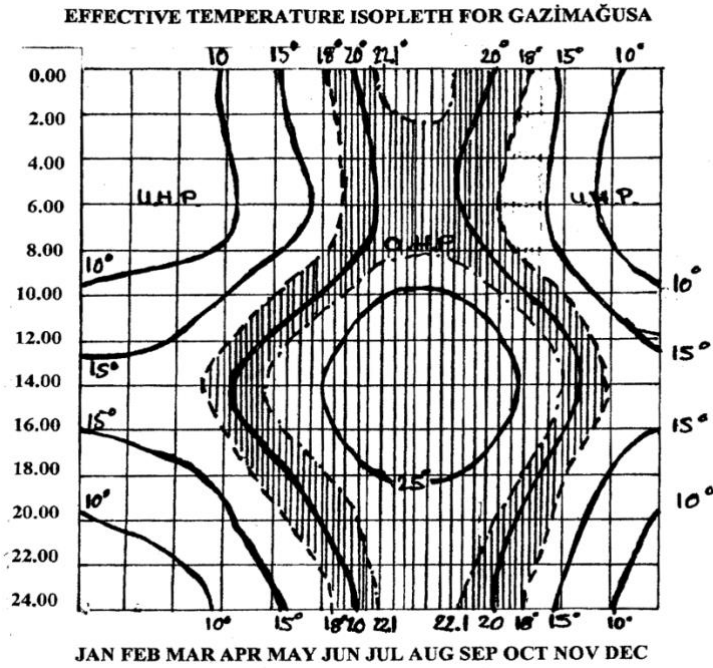


Figure 20. ET isopleths of various towns.

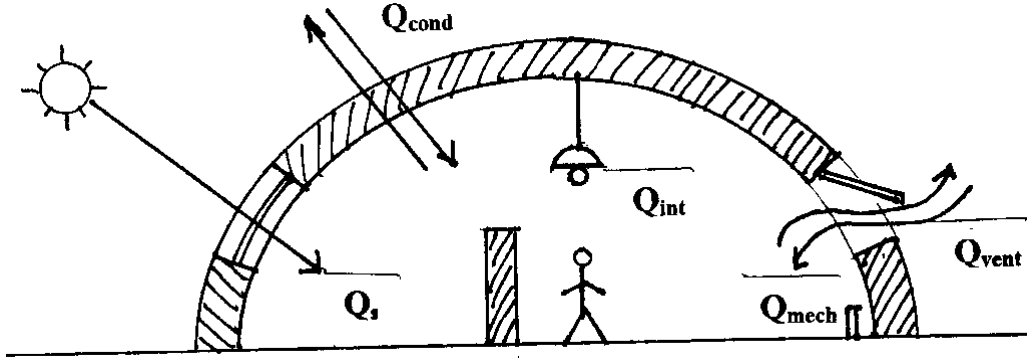


#### 4. THERMAL PROCESS OF BUILDINGS

Buildings continuously loose and gain heat.

$$+Q_{\text{int}} \pm Q_{\text{mech}} \pm Q_{\text{cond}} \pm Q_{\text{vent}} \pm Q_{\text{rad}} - Q_{\text{evp}} = 0$$

Figure 21. Diagram of a buildings thermal process.



##### INTERNAL HEAT GAIN

(By lamps, electrical appliances, users.)

##### MECHANICAL HEAT GAIN OR LOSS

(By heating and cooling appliances.)

##### HEAT GAIN OR LOSS BY CONDUCTION

(Through building elements.)

	Symbol	Unit	
Thermal conductivity, (reciprocal of $\lambda$ )	$(\lambda)$	W/mK	(ısı iletkenliği)
Thermal Resistivity,	$(1/\lambda)$	mK/W	(ısı iletkenlik direnci)

Thermal conductivity is amount of heat flowing from 1 m<sup>2</sup> area of 1 m thick building material when the temperature difference between the two sides is 1 degree Kelvin. Thermal Resistivity is the resistance to heat flow under the same conditions.

$\lambda = 0.03$  W/mK for good insulating material.

$\lambda = 400$  W/mK for a highly conductive metal.

Porous material have low thermal conductivity.

$\lambda = 0.026$  W/mK for air.

$\lambda = 0.580$  W/mK for water.

Thermal conductance,	$(\Lambda)$	W/m <sup>2</sup> K	(ısı geçirgenliği)
Thermal resistance,	$(R)$ or $(1/\Lambda)$	m <sup>2</sup> K/W	(ısı geçirgenlik direnci)

Thermal conductance is amount of heat flowing from 1 m<sup>2</sup> area of a building component with thickness (d), when the temperature difference between the two sides is 1 degree Kelvin.

Thermal Resistance is the resistance to heat flow under the same conditions.

For single layer building element:

$$R = 1/\Lambda = d/\lambda$$

For multilayer building element:

$$1/\Lambda = \sum d/\lambda = d_1/\lambda_1 + d_2/\lambda_2 + d_3/\lambda_3 + \dots + d_n/\lambda_n$$

Then we find the reciprocal of thermal resistance to find thermal conductance.

Cavity thermal conductance, ( $\Lambda_{cav}$ ) W/m<sup>2</sup>K (Boşluk ısı geçirgenliği)

Cavity thermal resistance, ( $1/\Lambda_{cav}$ ) m<sup>2</sup>K/W (Boşluk ısı geçirgenlik direnci)

Cavity thermal conductance is amount of heat flowing from 1 m<sup>2</sup> area of a cavity when the temperature difference between the two sides of the cavity is 1 degree Kelvin. Cavity thermal resistance is the resistance to heat flow under the same conditions.

Surface thermal conductance, ( $f$ ) W/m<sup>2</sup>K (Yüzeysel ısı iletim katsayısı)  
(film conductance)

Surface thermal resistance, ( $1/f$ ) m<sup>2</sup>K/W (Yüzeysel ısı iletim direnci)

Surface thermal conductance is the amount of heat flowing from or to 1 m<sup>2</sup> area of a surface when the temperature difference between the surface and air is 1 degree Kelvin. Surface thermal resistance is the resistance to heat flow under the same conditions.

Air-to-air thermal transmittance, ( $k$ ) W/m<sup>2</sup>K (Isı geçirme katsayısı)  
(U-value)

Air-to-air thermal resistance, ( $1/k$ ) m<sup>2</sup>K/W (Isı geçirme direnci)

Air-to-air thermal transmittance (U-value) is amount of heat flowing from air on one side to air on the other side of the building element when its surface area is 1 m<sup>2</sup> and the temperature difference between the air on two sides is 1 degree Kelvin. Air-to-air thermal resistance is the resistance to heat flow under the same conditions.

$$k = \frac{1}{\frac{1}{f_{out}} + \frac{1}{\Lambda} + \frac{1}{f_{in}}}$$

$$\frac{1}{k} = \frac{1}{f_{out}} + \frac{1}{\Lambda} + \frac{1}{f_{in}}$$

$$\text{Window \& Wall U-value} = k_{window\&wall} = \frac{(A_{wall} \cdot k_{wall}) + (A_{window} \cdot k_{window})}{A_{window} + A_{wall}}$$

TABLES

$$Q_{cond} = A \cdot k \cdot \Delta T$$

$$W \quad m^2 \quad \frac{W}{m^2K} \quad K$$

$$\Delta T = T_{oa} - T_{ia}$$

Sol-air temperature,  $T_s$

$$T_s = T_{oa} + \frac{L \cdot \alpha}{f}$$

$T_{oa}$  : Outside air temperature, °C

$I$  : Radiation intensity, W / m<sup>2</sup>

$\alpha$  : Solar absorbance coefficient,

$f$  : Surface conductance, W/m<sup>2</sup>K

### **HEAT GAIN AND LOSS BY VENTILATION**

$$Q_{vent} = 1300 \cdot V \cdot \Delta T$$

$Q_{vent}$  : Ventilation heat flow rate, W

1300 : Volumetric specific heat of air, J/ m<sup>3</sup> K

$V$  : Ventilation rate, m<sup>3</sup> / s

$\Delta T$  : Temperature difference between outside and inside air, K

$$V = \frac{N \cdot \text{Room volume}}{3600}$$

$N$  : No of air changes per hour

TABLE 1. THERMAL DESIGN DATA \*

No.	BUILDING MATERIALS OR COMPONENTS	DENSITY	THERMAL	VAPOUR
		D kg/m <sup>3</sup>	CONDUCTIVITY $\lambda$ W/m K	DIFFUSION RESISTIVITY FACTOR, $\mu$
1.	NATURAL STONES			
1.1	Metamorphic and volcanic stones with crystalline structure (granite, basalt, marble etc.)	$\geq 2800$	3.49	100
1.2	Sedimentary stones (sandstone, travertine etc.)	2600	2.32	22
1.3	Porous stones	$\leq 1600$	0.55	
2	SOILS (At natural moisture content)			
2.1	Sand, sand-gravel	1800	1.395	2
2.2	Clay, compacted soil	2000	2.09	
3	LAID MATERIAL (Air dried and top covered)			
3.1	Sand, gravel, crushed stone	1800	0.70	2
3.2	Crushed pumice	$\leq 1000$	0.19	
3.3	Blast-furnace slag	$\leq 600$	0.13	
3.4	Coal slag	$\leq 1000$	0.23	
3.5	Crushed porous stone	$\leq 1200$	0.22	2
		$\leq 1500$	0.27	2
3.6	Expanded perlite	$\leq 50$	0.046	
		$\leq 100$	0.058	
		$\leq 150$	0.069	
		$\leq 200$	0.08	
3.7	Granulated cork	$\leq 200$	0.05	
3.8	Polystyrene, hard foam pieces	15	0.045	1
3.9	Wood chips and sawdust	200	0.069	1
3.10	Straw, hay	150	0.058	
4	MORTARS, PLASTERS, SCREEDS			
4.1	Lime mortar, lime-cement mortar	1800	0.87	12, 25
4.2	Cement mortar	2000	1.395	30
4.3	Gypsum mortar, lime-gypsum mortar	1400	0.70	4, 9
4.4	Gypsum mortar without sand	1200	0.35	
4.5	Screed with gypsum mortar	2000	1.20	
4.6	Screed with cement mortar	2000	1.395	30
4.7	$\geq 15$ mm thick mastic asphalt	2300	0.895	200
4.8	Adobe mortar with straws in it	1200	0.46	
4.9	Mortars and plasters made of inorganic lightweight aggregates	800	0.30	3
		900	0.35	3
		1000	0.38	4
4.10	Mortars and plasters made of expanded perlite	400	0.14	2.5
		500	0.16	3
		600	0.20	3
		700	0.24	3
		800	0.29	3
5	BUILDING ELEMENTS AND COMPONENTS			
5.1	Normal Concrete			
	Reinforced	2400	2.09	60
	Without reinforcement	2200	1.74	29

No.	BUILDING MATERIALS OR COMPONENTS	DENSITY D kg/m <sup>3</sup>	THERMAL CONDUCTIVITY $\lambda$ W/m K	VAPOUR DIFFUSION RESISTIVITY FACTOR, $\mu$
5.2	Lightweight Concrete (with or without reinforcement, without any cavity between the aggregates)			
5.2.1	Lightweight concrete made of porous lightweight aggregate	1000 1200 1400 1600 1800 2000	0.46 0.58 0.72 0.87 0.99 1.20	4 6 10
5.2.2	Lightweight concrete made of pumice	1000 1100 1200 1300	0.38 0.44 0.5 0.55	4 6
5.2.3	Lightweight concrete made of expanded perlite	300 400 500 600 700 800 900 1000 1200 1400 1600	0.104 0.127 0.15 0.19 0.21 0.24 0.26 0.30 0.35 0.42 0.49	
5.3	Lightweight concretes which do not have fine aggregates and which have cavity between the aggregates.			
5.3.1	Lightweight concrete with unporous aggregates (like gravel)	1600 1800 2000	0.81 1.10 1.395	10 15 22
5.3.2	Lightweight concrete with porous lightweight aggregates	600 700 800 1000 1200 1400 1600 1800 2000	0.22 0.25 0.28 0.36 0.46 0.57 0.76 0.92 1.20	3 3 4 6 10 12 18
5.3.3	Lightweight concrete made of pumice only	600 700 800 900 1000 1200	0.19 0.21 0.24 0.26 0.33 0.44	3 3 4 6



No.	BUILDING MATERIALS OR COMPONENTS	DENSITY D kg/m <sup>3</sup>	THERMAL CONDUCTIVITY $\lambda$ W/m K	VAPOUR DIFFUSION RESISTIVITY FACTOR, $\mu$
5.4	Lightweight concrete made of organic aggregates			
5.4.1	Lightweight concrete made of wood chips and sawdust	400 600 800 1000 1200	0.14 0.19 0.26 0.35 0.44	3 3.5
5.4.2	Lightweight concrete made of straw	600 700	0.14 0.17	
6	BUILDING SLABS, PANELS			
6.1	Asbestos-cement slab	2000	0.58	5
6.2	Aerated concrete slabs	400 500 600 700 800	0.14 0.16 0.19 0.21 0.23	2 3 5 7
6.3	Lightweight concrete wall slabs	800 900 1000 1200 1400	0.29 0.32 0.37 0.46 0.58	3 4 6 10
6.4	Gypsum wall panels and slabs	600 750 900 1000 1200	0.29 0.35 0.40 0.46 0.58	5
6.5	Expanded perlite mixed gypsum wall panels	600 750 900	0.17 0.20 0.22	
6.6	Gypsum plaster boards	900	0.21	8
7	WALLS			
	Brick walls			
7.1.1	Walls made of solid or vertical holed normal bricks	$\leq 1200$ 1400 1600 1800 2000 2200	0.50 0.58 0.69 0.81 0.97 1.20	5 - 3 6 8 11
7.1.2	Walls made of vertical holed lightweight bricks (AB Class bricks)	$\leq 700$ 800 900 1000	0.35 0.38 0.42 0.45	2

No.	BUILDING MATERIALS OR COMPONENTS	DENSITY	THERMAL	VAPOUR
		D kg/m <sup>3</sup>	CONDUCTIVITY $\lambda$ W/m K	DIFFUSION RESISTIVITY FACTOR, $\mu$
7.1.3	Walls made of vertical holed lightweight bricks (w Class bricks)	$\leq 700$	0.30	2
		800	0.32	
		900	0.36	
		1000	0.39	
7.1.4	Walls made of horizontal holed bricks	$\leq 1000$	0.45	3
7.2	Walls made of lime and sand stone	1000	0.50	4
		1200	0.57	
		1400	0.70	
		1600	0.79	
		1800	0.99	
		2000	1.10	
7.3	Walls made of aerated concrete blocks			
7.3.1	Walls in which aerated concrete blocks are jointed with ordinary cement mortar	400	0.20	
		500	0.22	
		600	0.24	
		700	0.27	
		800	0.29	
7.3.2	Walls in which aerated concrete blocks are jointed with special mortars and the joint width is $\geq 3$ mm	400	0.16	2
		500	0.19	3
		600	0.22	5
		700	0.24	
		800	0.27	7
7.4	Walls made of solid concrete briquettes or solid concrete wall blocks			
7.4.1	Walls made of lightweight or normal concrete solid briquettes or solid blocks	500	0.32	3
		600	0.35	
		700	0.37	
		800	0.39	
		900	0.43	
		1000	0.46	
		1200	0.53	
		1400	0.63	
		1600	0.73	
		1800	0.87	
		2000	0.99	
2200	1.20			
7.4.2	Walls made of solid blocks which are made of pumice concrete	500	0.29	
		600	0.32	
		700	0.35	
		800	0.38	
		900	0.43	
		1000	0.46	
1200	0.53			
7.4.3	Walls made of solid blocks which are made of expanded perlite concrete	500	0.26	
		600	0.29	
		700	0.33	
		800	0.35	

No.	BUILDING MATERIALS OR COMPONENTS	DENSITY	THERMAL	VAPOUR
		D kg/m <sup>3</sup>	CONDUCTIVITY $\lambda$ W/m K	DIFFUSION RESISTIVITY FACTOR, $\mu$
7.5	Walls made of hollow blocks or briquettes			
7.5.1	Walls made of blocks or briquettes which have at least two rows of holes	500 600 700 800 900 1000 1200 1400 1600	0.29 0.33 0.35 0.38 0.44 0.49 0.60 0.73 0.87	
7.5.2	Walls made of blocks or briquettes which have only one row of holes	$\leq$ 700 800 900 1000 1200	0.56 0.61 0.69 0.77 0.95	
7.6	Walls made of irregular natural stones Stone density < 1600 kg/m <sup>3</sup> 1600-2000 kg/m <sup>3</sup> 2000-2600 kg/m <sup>3</sup> $\geq$ 2600 kg/m <sup>3</sup>		0.81 1.16 1.74 2.56	
7.7.	Adobe walls			
7.7.1	Adobe walls free from additives	> 1700	0.93	
7.7.2	Adobe walls made of straw mixed adobe	< 1700	0.70	
8.	TIMBER AND TIMBER PRODUCTS			
8.1	Timber			
8.1.1	Timber of evergreen trees	600	0.13	70
8.1.2	Timber of beech (fagus sylvatica ), oak	800	0.20	60
8.2	Timber products			
8.2.1	Plywood	800	0.15	70
8.2.2	Chipboards			
8.2.2.1	Chips bonded along the board	700	0.13	
8.2.2.2	Chips bonded across the board	700	0.17	
8.2.3	Fibreboards (Hardboards)			
8.2.3.1	Hard and medium density fibreboards	600 800 1000	0.13 0.15 0.17	70
8.2.3.2	Light fibreboards	$\leq$ 200 $\leq$ 300	0.046 0.058	
9	SHEETS AND TILES			
9.1	Floorings			
9.1.1	Linoleum	1000	0.17	500
9.1.2	Cork carpet	700	0.08	200
9.1.3	Flexible vinyl, PVC	1500	0.23	10000
9.1.4	Carpets	250	0.07	1

No.	BUILDING MATERIALS OR COMPONENTS	DENSITY	THERMAL	VAPOUR
		D kg/m <sup>3</sup>	CONDUCTIVITY $\lambda$ W/m K	DIFFUSION RESISTIVITY FACTOR, $\mu$
9.2	Water insulation sheets			
9.2.1	Mastic asphalt $\geq 7$ mm	2000	0.81	250
9.2.2	Bituminous damp proof membranes	1100	0.20	14000
10	HEAT INSULATION MATERIALS			
10.1	Cement-chipboard insulating plates			
	Plate thickness $\geq 25$ mm	360 - 460	0.09	7
	Plate thickness = 15 mm	570	0.15	11
10.2	Synthetic foam materials			
10.2.1	Polystyrene hard foam plates	$\geq 15$	0.0395	
10.2.2	Polyurethane hard foam plates	$\geq 30$	0.0349	
10.2.3	Phenolic resin hard foam plates	$\geq 30$	0.0395	
10.3	Heat insulating materials made of mineral fibres (including GLASSWOOL )	8-200	0.0395	1 - 2
10.4	Heat insulating materials made of plant fibres	15-200	0.046	
10.5	Glass foam plates	100-150	0.058	10 000
10.6	Cork plates	80-160 >160-250 >250-500	0.045 0.050 0.055	10 30 35
10.7	Lightweight plates made of bamboo	150-200	0.058	1
11	THE OTHER MATERIALS			
11.1	Glass	2500	0.81	10 000
11.2	Ceramic tiles	2000	0.99	200-300
11.3	Ceramic or glass mosaic	2000	1.20	60-140
12	METALS			
12.1	Steel	7850	60.5	
12.2	Copper	8900	380.0	
12.3	Aluminium	2700	200.0	
13	RUBBER			
		1000	0.20	

\* Thermal Conductivities are taken from Turkish Standard TS825 and Vapour Diffusion Resistivity Factors are taken from the German Standard DIN 4108.

TABLE 2 : Surface thermal conductances and resistances (TS 825)

Surfaces	Surface Conductance f W/m <sup>2</sup> K	Surface Resistance 1/f m <sup>2</sup> K/W
<b>INTERNAL SURFACES</b>		
Wall and internal window	8.14	<b>0.12</b>
External window	11.63	0.086
Floor with hot side at the bottom	8.14	0.12
Floor with hot side at the top	5.81	0.17
<b>EXTERNAL SURFACES</b>	20	<b>0.043</b>

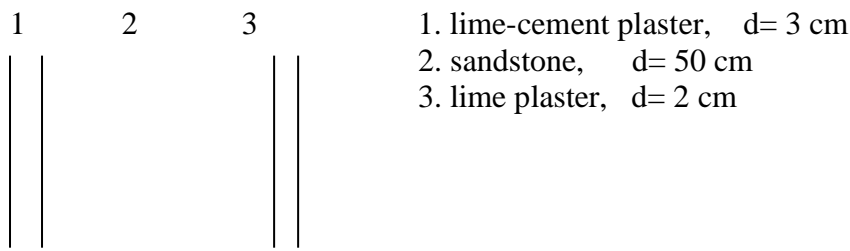
TABLE 3: Cavity thermal conductance and resistance (TS 825).

CAVITY POSITION and THICKNESS	Cavity Conductance $\Lambda_{cav}$ W/m <sup>2</sup> K	Cavity Resistance 1/ $\Lambda_{cav}$ m <sup>2</sup> K/ W
VERTICAL 10 – 20 mm	7.27	0.14
20 – 500 mm	5.81	0.17
HORIZONTAL 10- 500 mm	5.81	0.17

TABLE 4: U-values of some building components (TS 825)

COMPONENT	U-value W/m <sup>2</sup> K
<b>TIMBER OR PLASTIC WINDOWS and DOORS</b>	
With single glazing	5.2
Double glazing with 6 mm spacing	3.3
Double glazing with 12 mm spacing	2.9
External door without glazing	3.5
<b>METAL WINDOWS and DOORS</b>	
With single glazing	5.8
Double glazing with 6 mm spacing	4.0
Double glazing with 12 mm spacing	3.6
Skylight with single glazing	5.8
Skylight with double glazing	3.5

EXAMPLE:



QUESTION: What is thermal resistance, thermal conductance, air-to-air transmittance (U value) and air-to-air resistance of this wall?

$$\lambda_1 = 0.87 \text{ W/mK}$$

$$\lambda_2 = 2.32 \text{ W/mK}$$

$$\lambda_3 = 0.87 \text{ W/mK}$$

Thermal Resistance :

$$\begin{aligned} 1/\Lambda &= \sum d/\lambda = d_1/\lambda_1 + d_2/\lambda_2 + d_3/\lambda_3 = \frac{0.03}{0.87} + \frac{0.50}{2.32} + \frac{0.02}{0.87} \\ &= 0.034 + 0.21 + 0.023 = 0.267 \text{ m}^2\text{K/W} \end{aligned}$$

Thermal Conductance :

$$\Lambda = 1 / \sum d/\lambda = \frac{1}{0.267} = 3.74 \text{ W/m}^2\text{K}$$

Air-to-air thermal resistance :

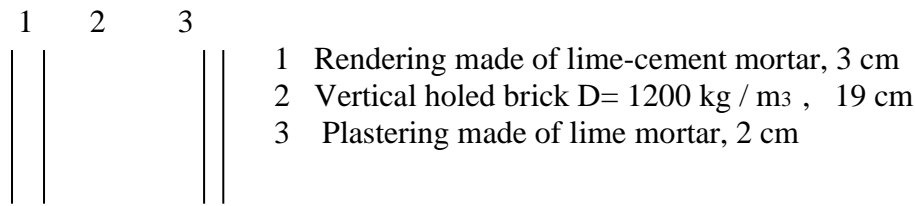
$$\frac{1}{k} = \frac{1}{f_{\text{out}}} + \frac{1}{\Lambda} + \frac{1}{f_{\text{in}}} = 0.043 + 0.267 + 0.12 = 0.43 \text{ m}^2\text{K/W}$$

Air-to-air thermal transmittance (U-value) :

$$k = \frac{1}{\frac{1}{f_{\text{out}}} + \frac{1}{\Lambda} + \frac{1}{f_{\text{in}}}} = \frac{1}{1/k} = \frac{1}{0.43} = 2.32 \text{ W/m}^2\text{K}$$

EXAMPLE

A building façade is made of 24 m<sup>2</sup> brick wall and 6 m<sup>2</sup> single glazing window k = 5.2 W/m<sup>2</sup>K .



- A) Find the thermal resistance?
- B) Find the U-Value ?
- C) Find the (Window + Wall) U-Value ?

A)

$$\frac{1}{\Lambda} = \sum \frac{d}{\lambda} = \frac{d_1}{\lambda_1} + \frac{d_2}{\lambda_2} + \frac{d_3}{\lambda_3} = \frac{0.03 \text{ m}}{0.87 \text{ W/mK}} + \frac{0.19 \text{ m}}{0.50 \text{ W/mK}} + \frac{0.02 \text{ m}}{0.87 \text{ W/mK}}$$

$$= 0.034 + 0.38 + 0.023 = 0.437 \text{ m}^2\text{K/W}$$

B)

$$k \text{ (U-Value)} = \frac{1}{\frac{1}{f_{out}} + \frac{1}{\Lambda} + \frac{1}{f_{in}}} = \frac{1}{0.043 + 0.437 + 0.12 \text{ m}^2\text{K/W}}$$

$$= 1.666 \text{ W/m}^2\text{K}$$

C)

$$k_{\text{window\&wall}} = \frac{(A_{\text{wall}} \cdot k_{\text{wall}}) + (A_{\text{window}} \cdot k_{\text{window}})}{A_{\text{window}} + A_{\text{wall}}} = \frac{(1.666 \times 24) + (5.2 \times 6)}{30}$$

$$= 2.36 \text{ W/m}^2\text{K}$$

### **HEAT GAIN AND LOSS BY RADIATION**

Solar heat gain and radiation heat loss through the opaque building elements can be described with the use of Sol-air Temperature concept in conduction heat flow equation.

Solar heat gain through windows can be found with the following equation:

$$Q_s = A \cdot I \cdot \Theta$$

W      m<sup>2</sup>    W/ m<sup>2</sup>

$Q_s$  : Solar radiation through windows, W

$A$  : Area of the window, m<sup>2</sup>

$I$  : Radiation intensity, W/

$\Theta$  : Solar gain factor (Depends on glass type and solar incidence angle)

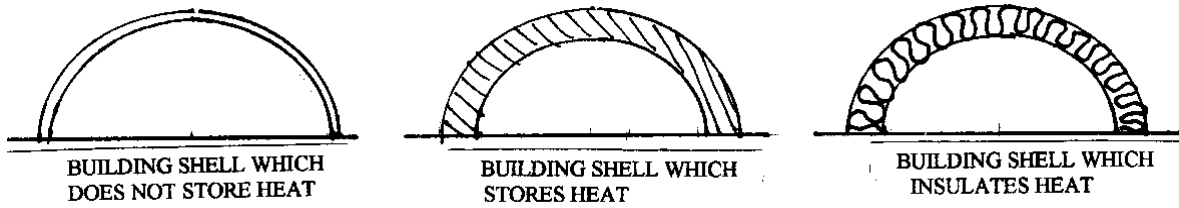
### **HEAT LOSS BY EVAPORATION**

Most of the building materials (not all of them) are porous. After they get wet, during the drying process they get heat away from the building. It is not easy to calculate this heat loss. Instead, we design the buildings so that they don't get wet. (Overhangs, eaves, horizontal projections on facades, window sills, etc.)



## 5. THERMAL CONTROL

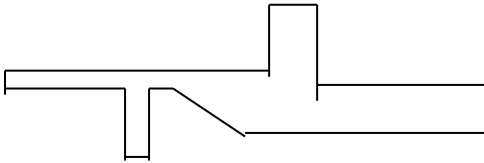
Figure 22. Diagrammatic explanation of building types for thermal control.



Cool Climates  
 Hot-dry Climates  
 Hot-humid Climates  
 Temperate Climates

F/V  
 Spherical building forms. Igloo, Dome.  
 Cubical building forms.

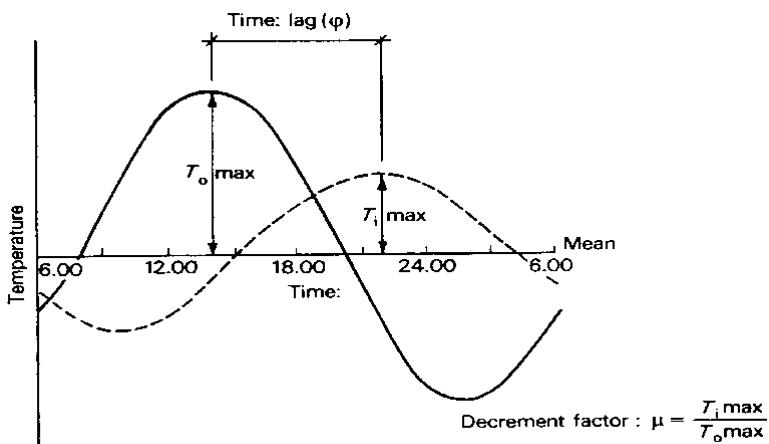
Figure 23. A staggered building plan.



Cross ventilation.

Time-lag,  $\Phi$   
 Decrement factor,  $\mu$   
 Deviation from mean

Figure 24. Graph of temperature variations on a building element.



Every country has somewhat different regulations for thermal comfort.

Turkish Thermal Control Regulations. (16 January 1985)

Turkey was divided into three thermal zones.

- The minimum thermal resistances.
- The maximum Air-to-air thermal transmittance for the building facade

## 6. CONDENSATION CONTROL

Condensation is forming of water drops when water vapour touches a cool surface.

It is not enough to use too thick thermal insulation on buildings. The thermal insulation should be at the correct position on the external building element. If we don't use the thermal insulation at the correct position, condensation may occur and building element may get wet. Thus it doesn't insulate heat.

When the water vapour in the air meets with a cold building element it condenses and wets the building element. A wet building elements results in more energy consumption and also in deterioration of decorations.

There are many methods to control condensation in buildings.

### Dew Point Method

This is an easy method to control condensation in buildings. In this method we need to know temperature and vapour pressure gradients across the building element according to the design temperatures.

Temperature Gradient

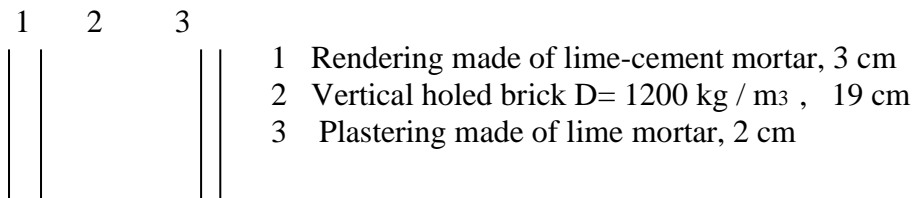
Vapour Pressure Gradient

Design Temperatures:

Indoors 21 °C

Outdoors (Read from tables in Thermal Regulations)

Let's try the method on an external wall for winter, where outside design temperature is -12 °C.



To find the temperature gradient we should draw a graph showing this wall in terms of thermal resistance.

To find the vapour pressure gradient we should draw another graph showing this wall in terms of vapour resistance.

$\mu$  : Vapour Diffusion Resistivity Factor

$$\mu = \frac{\text{Vapour resistivity of the material}}{\text{Vapour resistivity of air}}$$

$\mu d$  : Vapour resistance

When Indoor design temperature is  $21\text{ }^{\circ}\text{C}$  and Outdoor design temperature is  $-12\text{ }^{\circ}\text{C}$  we can find the temperature gradient from the first graph.

We find indoor and outdoor vapour pressures from design temperature and relative humidity.

From  $21\text{ }^{\circ}\text{C}$  and 50% RH indoor vapour pressure is  $1300\text{ N/m}^2$  .

From  $-12\text{ }^{\circ}\text{C}$  and 80% RH indoor vapour pressure is  $200\text{ N/m}^2$  .

By plotting these values and connecting them in the second graph we find the vapour pressure gradient. Then we find the dew point temperature for each intersection point and draw them to the first graph. Connecting these points with dotted lines will give us dew point temperature line. There will be condensation risk if dew point temperature line is above the temperature line.

In cool climates or in places where cool seasons are longer than the warm seasons there are two solutions.

1. To use thermal insulation materials towards the outer layers.
2. To use vapour barriers on the inner layers.

Normally, the first solution is used in cool climates. The second solution is used at spaces where relative humidity is high, like bathrooms, kitchens etc.

In hot climates or in places where summers are longer than the winters reverse is true. Thermal insulation should be towards the inner layers. There is another reason for this besides the condensation. During the day sunshine will bombard the external wall. If the thermal insulation is on the external layer, the heat enters the wall cannot flow outward, when the temperature falls at night. Thus, inside the building it will be very hot.

Figure 25. Preparation of condensation control graphs.

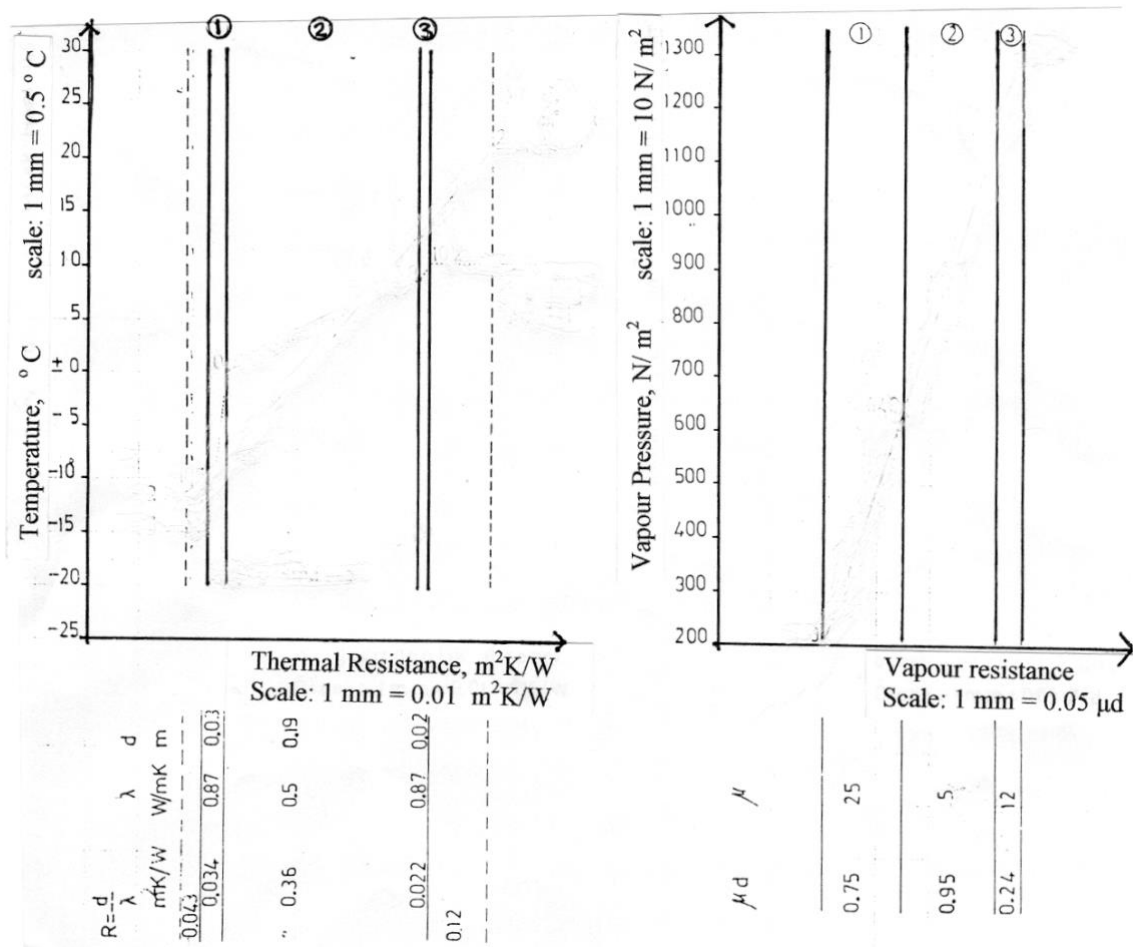
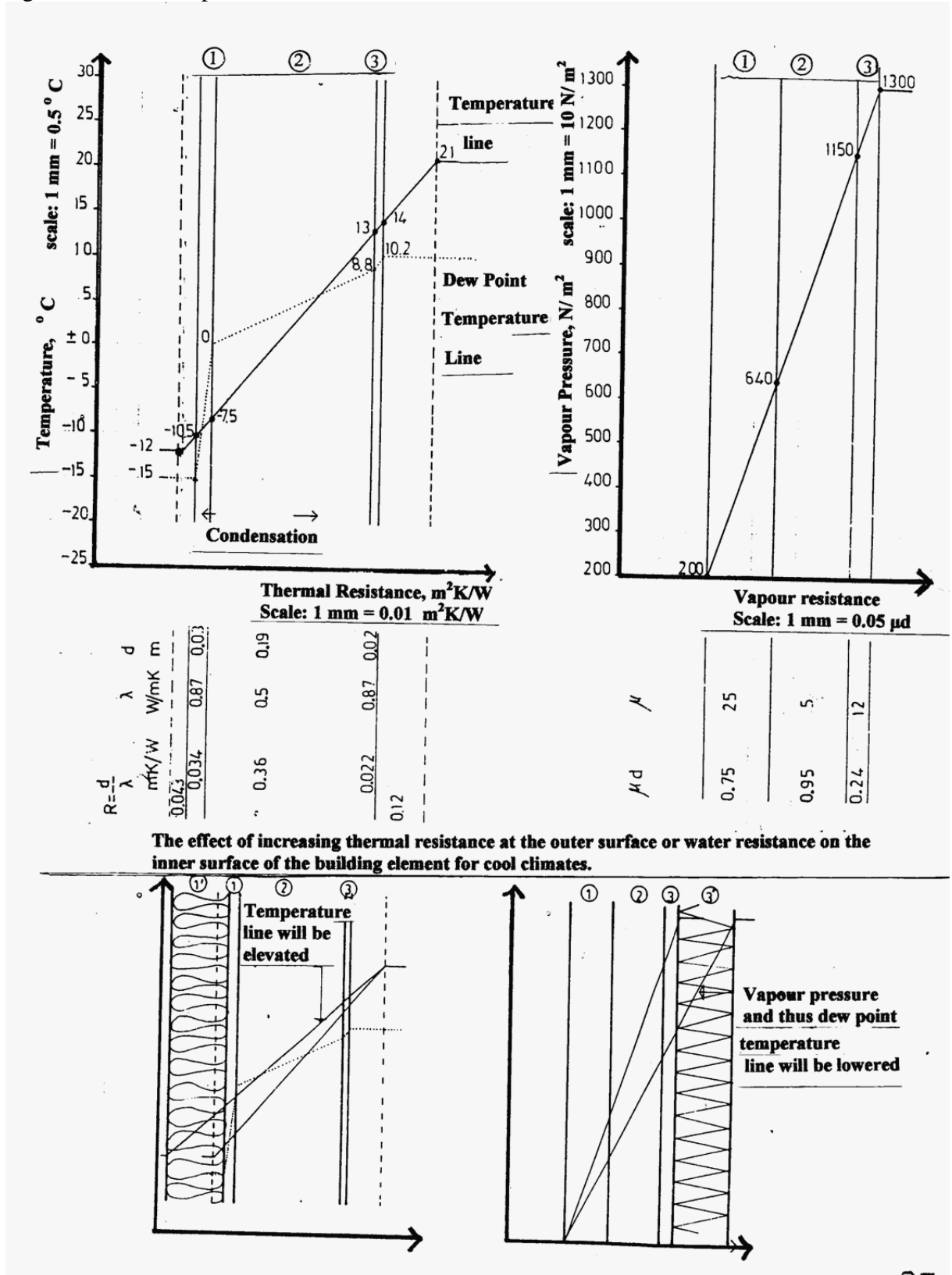


Figure 26. An example of condensation control.



## 7. SOLAR CONTROL

In architecture sunshine is admitted to building to heat it. However, when the sunshine is too much we try to control it. This is done with the shading devices. There are mainly two types of shading devices.

1. Movable Shading Devices  
(Like curtains, shutters, internal and external blinds, etc. They are closed when the sunshine is too much and opened when we need sunshine.)
2. Structural Shading Devices  
(They are static so they have to be designed carefully to allow sunshine when it is required and keep it out when not required.

There are three types of structural shading devices.)

- . Vertical Shading Device
- . Horizontal Shading Device
- . Egg-crate Shading Device

To show performance of shading devices shadow angles are used. There are two shadow angles.

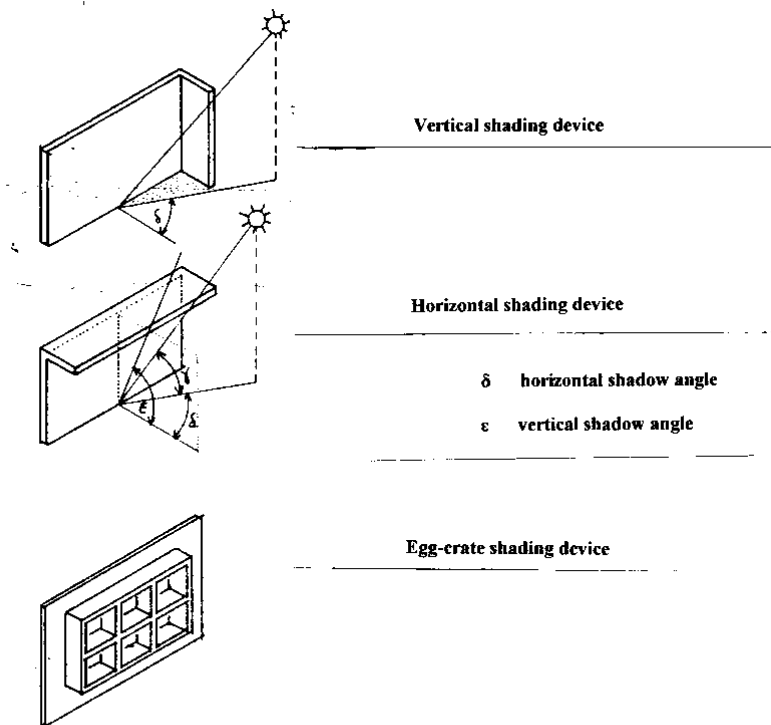
1. Horizontal Shadow Angle
2. Vertical Shadow Angle

Shadow angle is different according to each point selected on building façade. To show the performance of vertical shading devices *horizontal shadow angle* ( $\delta$ ) is used. To show performance of horizontal shading device *vertical shadow angle* ( $\epsilon$ ) is used. To show the performance of egg-crate shading device both of the shadow angles are used. Shadow angles are always taken from a line perpendicular to the building façade at the selected point. There are two types of horizontal shadow angle. The horizontal shadow angle clockwise is defined as (+), and horizontal shadow angle anticlockwise is defined as (-).

Shadow Angle Protractor shows the projections of shadow angles. The diameter of the shadow angle protractor is the projection of building façade and the radius perpendicular to this diameter is the projection of the line that is perpendicular to the façade. To the left of this perpendicular line (-) horizontal shadow angles and to the right (+) horizontal shadow angles are given in 10 degrees intervals. The curves with continuous lines are the projections of vertical shadow angles in 10 degrees intervals. Shadow angle protractors are prepared by the stereographic projection method and they can be used with stereographic sun path diagrams of the same size. By the use of shadow angle protractor, scaled plans and sections of the shading devices we can find the shadow angles. Shadow Angle Mask is a half circular graph that shows the shadow angles of a shading device. Examples of finding the shadow angles and shadow masks are given in the following figures.

If we wish to find shadow angles of a shading device so that 100% shadowing is made, plan and section of it is drawn. If shading device is vertical, on plan we draw a perpendicular line to the wall from the right side of the window. Then we draw the line that connects the right side of the window to the corner of the vertical shading device on the left. The angle between these two lines is the (-) horizontal shadow angle. When the sun is outside this angle 100% of the window will be in the shade. Then we draw another perpendicular line to the wall from the left side of the window and the line connecting the left side of the window to the corner of

Figure 27. Shading devices and shadow angles.



the vertical shading device on the right. The angle between these two lines is the (+) horizontal shadow angle. When we draw these angles on a half circle and hatch the parts to show 100% shading conditions we obtain shading mask of the shading device.

For the horizontal shading device we draw its section. Then we draw a line perpendicular to the wall from the bottom of the window and another line connecting the bottom of the window to the corner of the horizontal shading device. The angle between these two lines is the vertical shadow angle. We measure it with a normal protractor. We find its projection on the shadow angle protractor and draw it on a half circle showing the 100% shading condition.

If we can find the shading mask when a shading device is given, we can also design the shading device when the mask and the sizes of the window are given. For each shading mask there are hundreds of shading device solutions. The designer considers other design issues in making the choice. Then how can we find the necessary shading mask for a specific location and orientation? For this purpose we put the transparent shadow angle protractor on the overheated period plotted sun path diagram, so that projection of the line perpendicular to the façade overlays the wall azimuth. “Wall Azimuth” is the angle between the line perpendicular to the façade and the north direction. Then we try to read the shadow angles that will cover the dark hatched overheated period. While doing this we try to read the smallest angles and we do not make shadows for the times the building is not used.

For south orientations the overheated period can be covered by vertical shadow angles. Thus we need only horizontal shading devices. For east and west orientations the overheated period can be covered by horizontal shadow angles. Thus we need only the vertical shading devices. For southeast and southwest orientations overheated period can be covered both by the vertical and horizontal shadow angles. Thus we need to use both the horizontal and vertical shading devices.

Figure 28. Some examples of the shading devices and shadow masks.

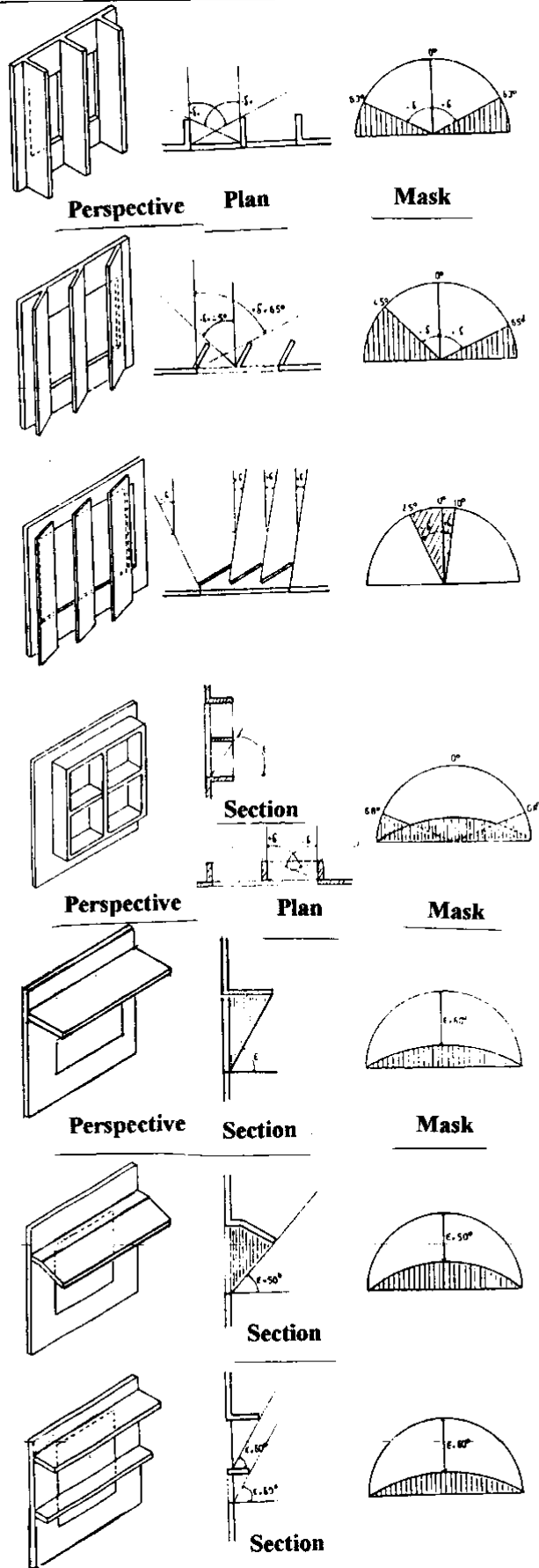




Figure 29.

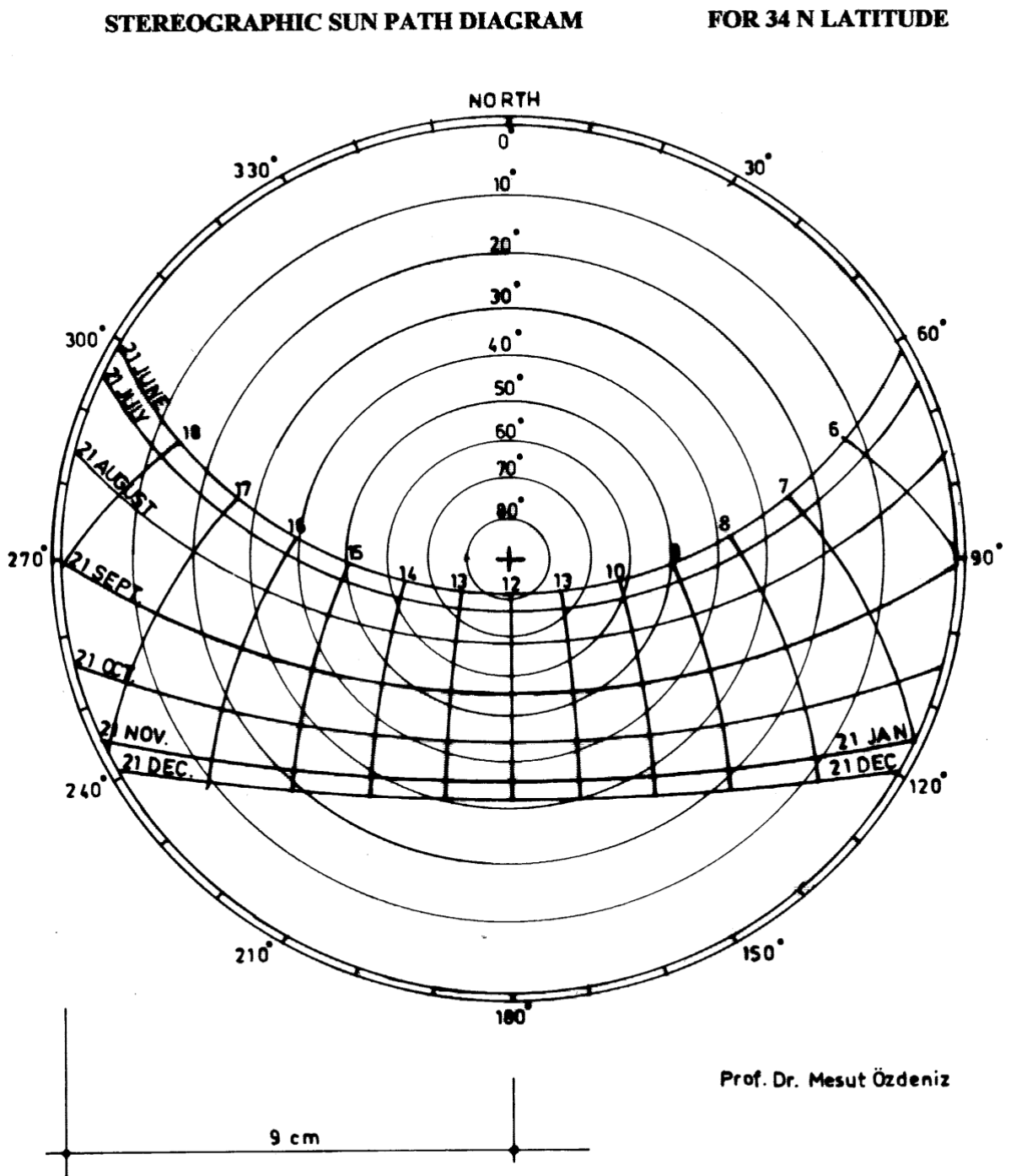
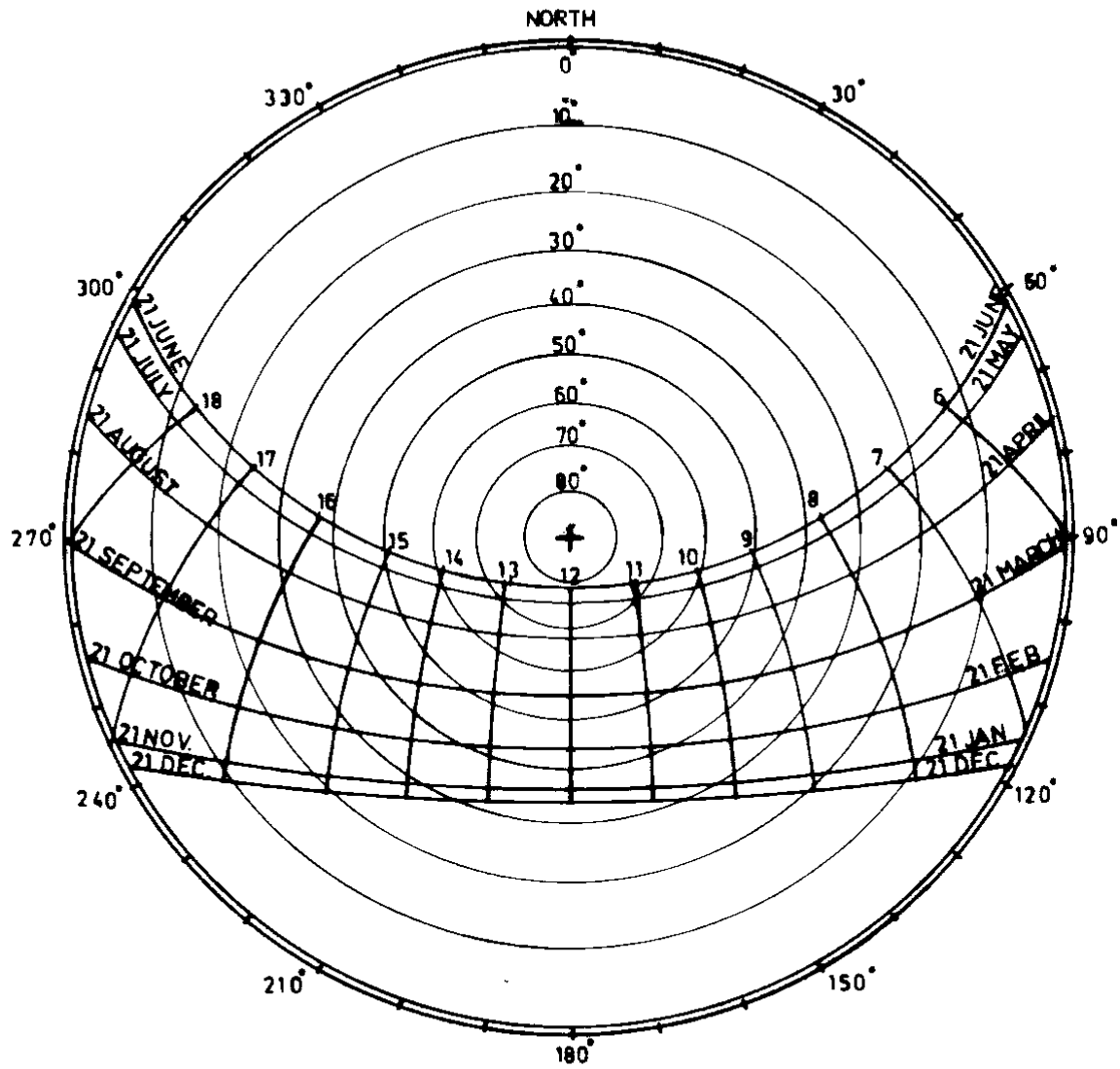


Figure 30.

**STEREOGRAPHIC SUN PATH DIAGRAM**

**FOR 35 N LATITUDE**



Prof. Dr. Mesut B. Özdeniz

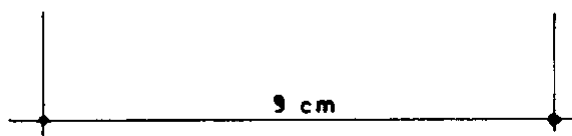
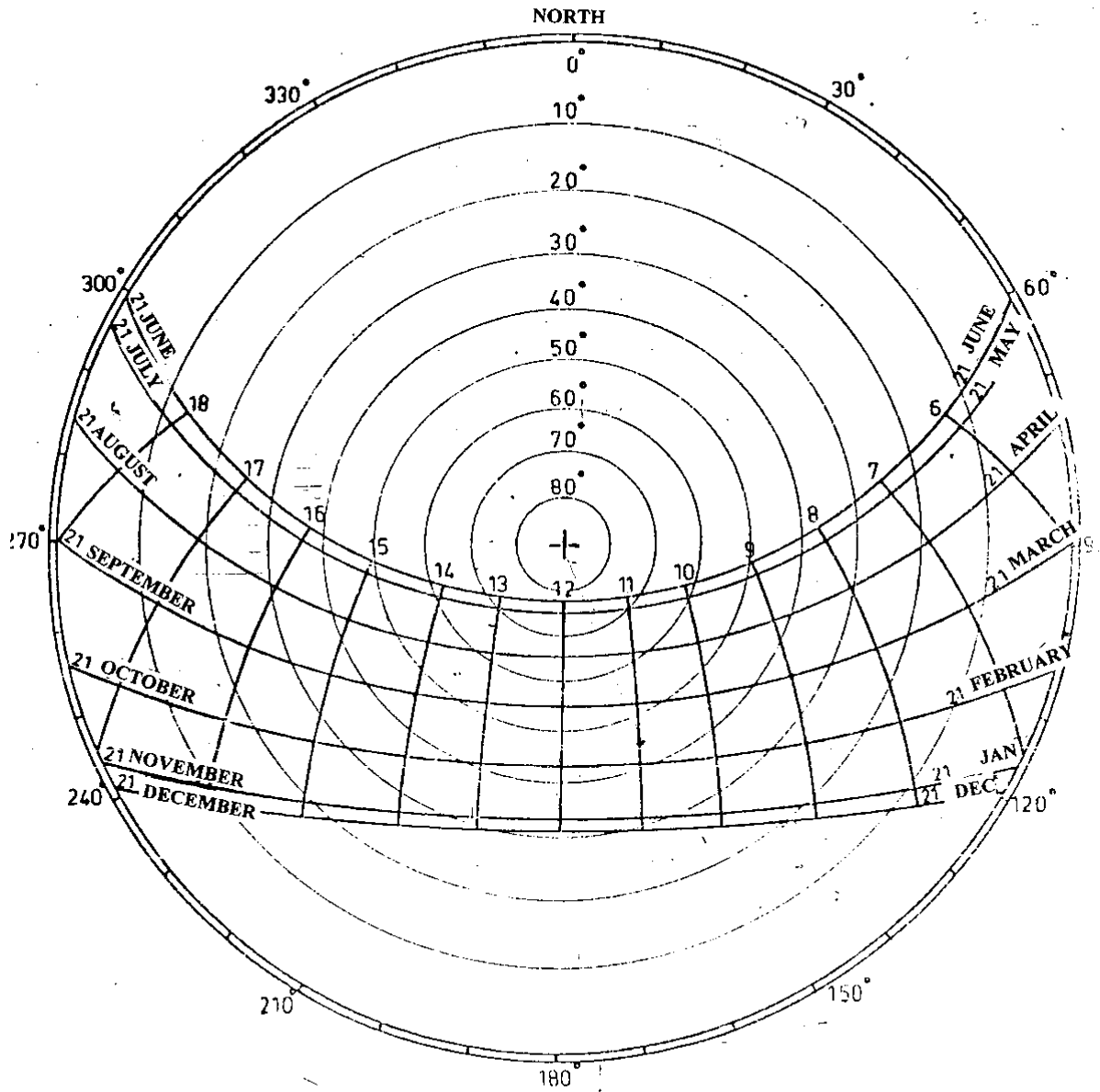


Figure 31.

**STEREOGRAPHIC SUN PATH DIAGRAM**

**FOR 36° N  
LATITUDE**



Dr. Mesut Özdeniz

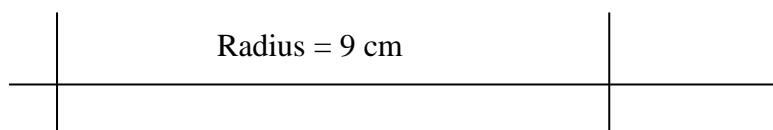
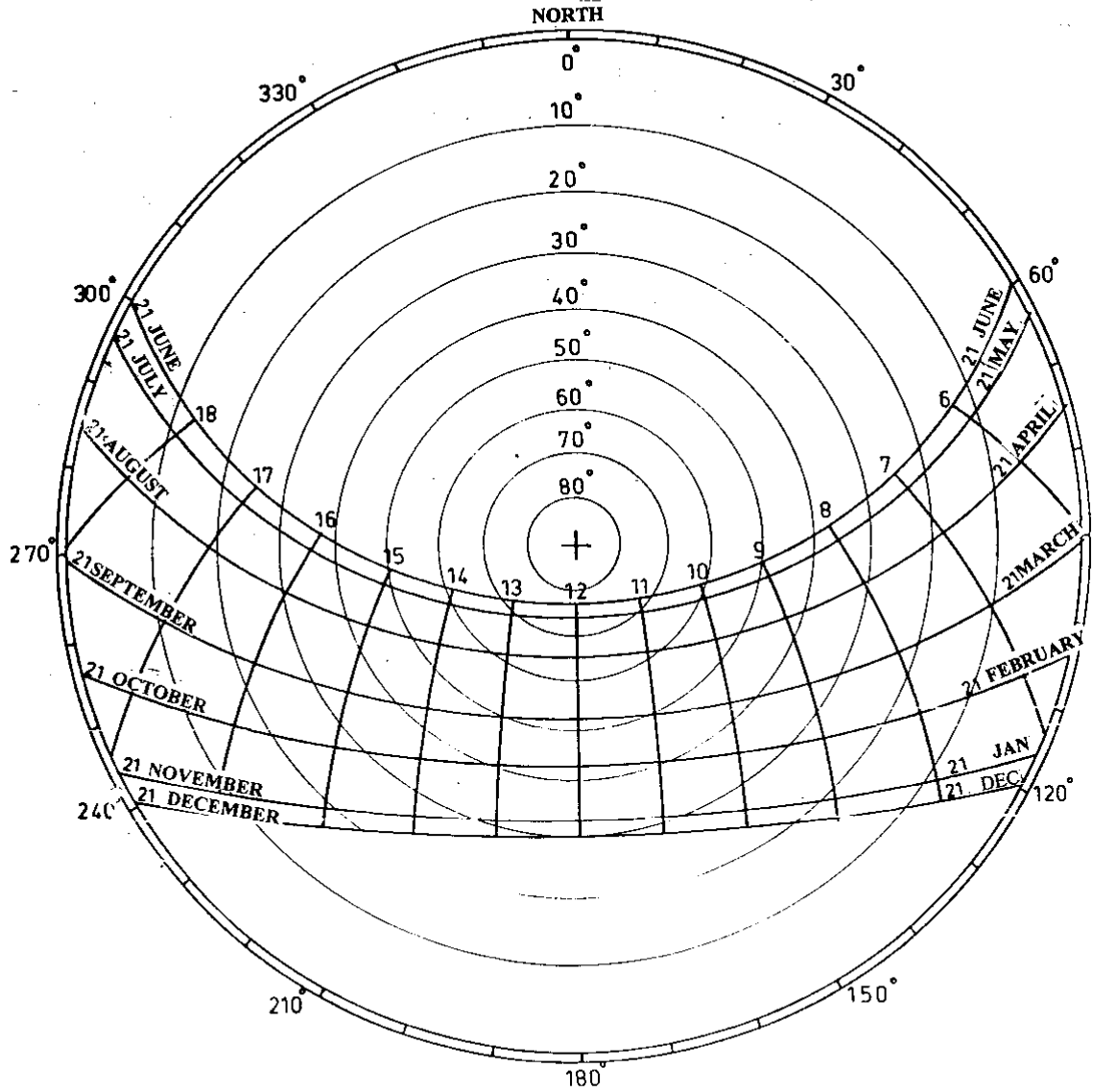


Figure 32.

**STEREOGRAPHIC SUN PATH DIAGRAM**

**FOR 37° N  
LATITUDE**



Dr. Mesut Özdeniz

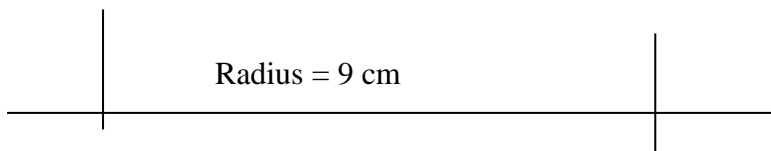
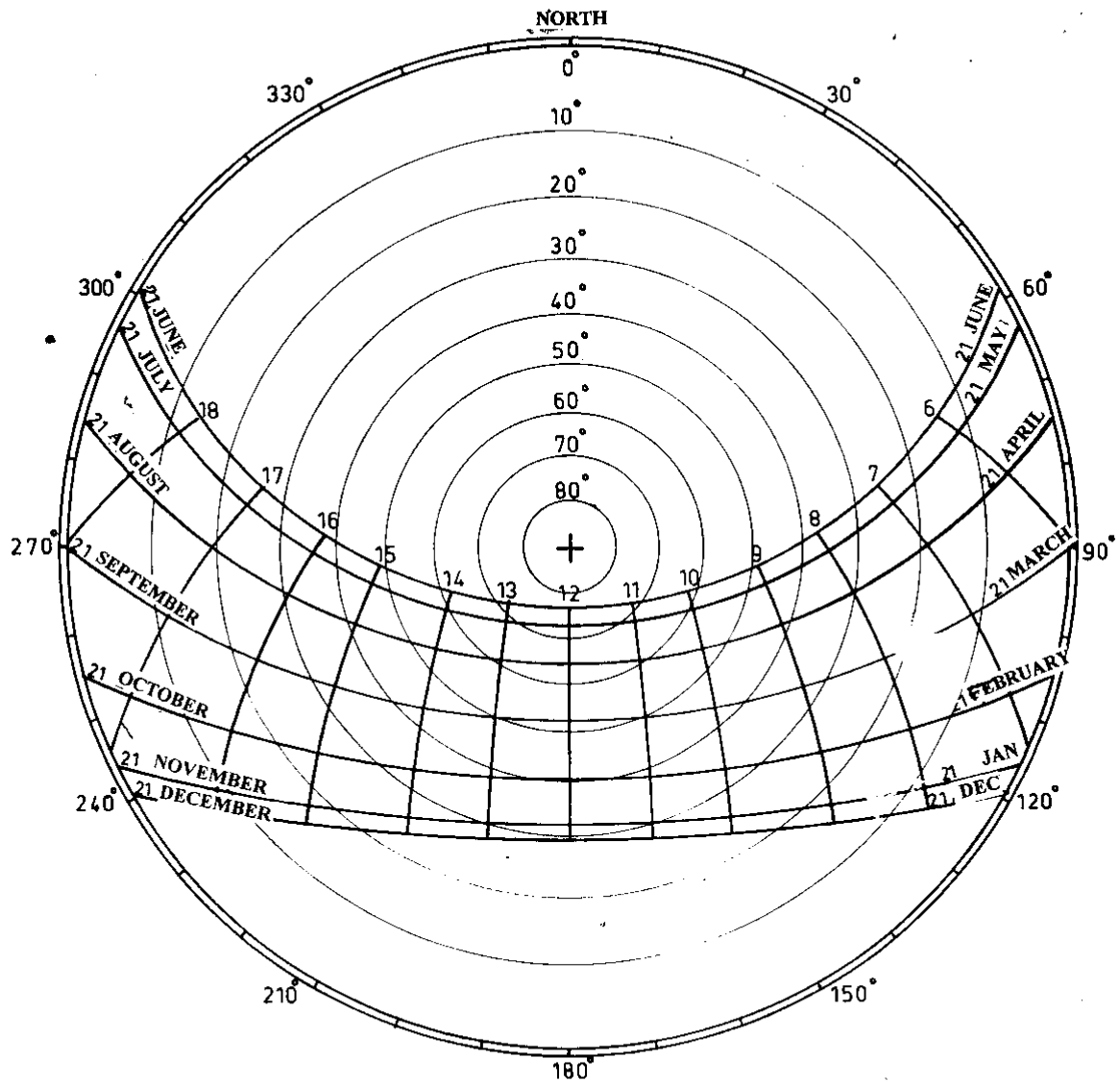


Figure 33.

**STEREOGRAPHIC SUN PATH DIAGRAM**

**FOR 38° N  
LATITUDE**



Dr. Mesut Özdeniz

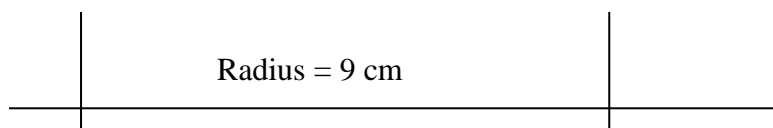
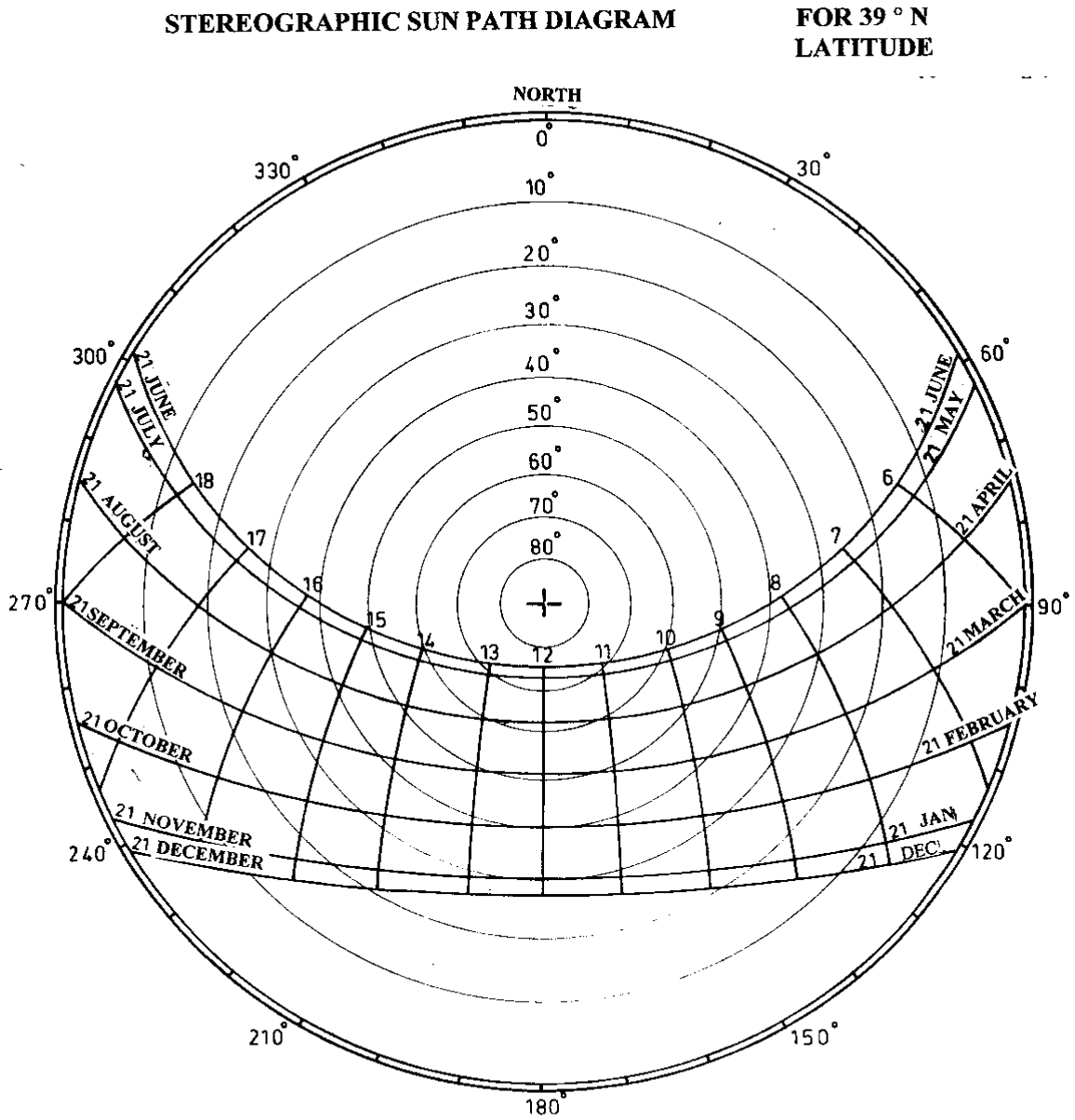


Figure 34.



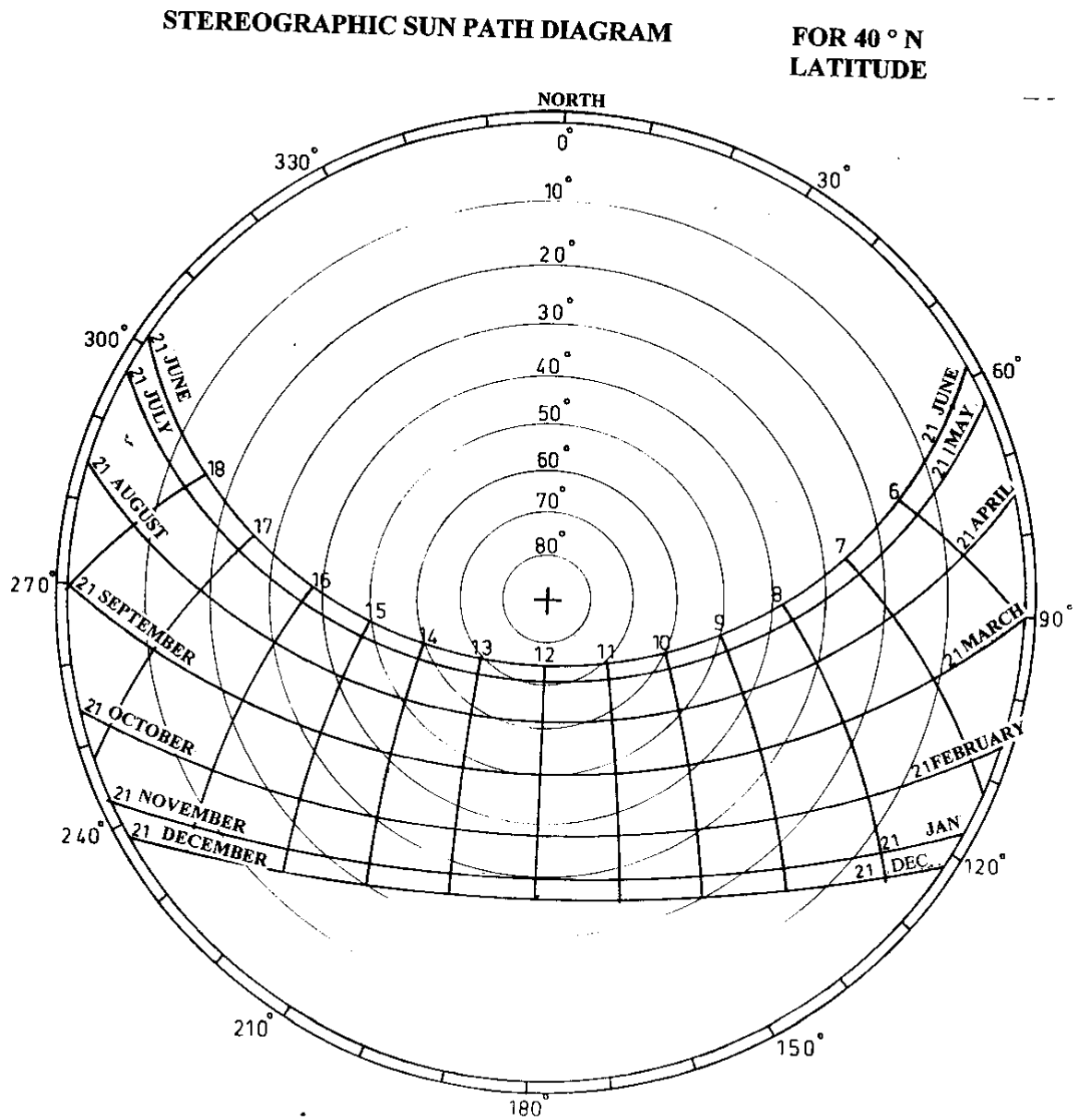
Dr. Mesut Özdeniz

|-----|

Radius = 9 cm

|-----|

Figure 35.



Dr. Mesut Özdeniz

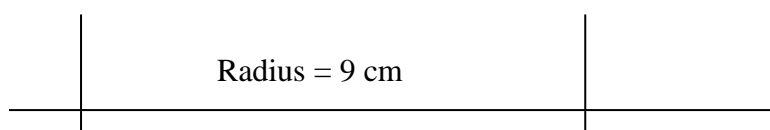
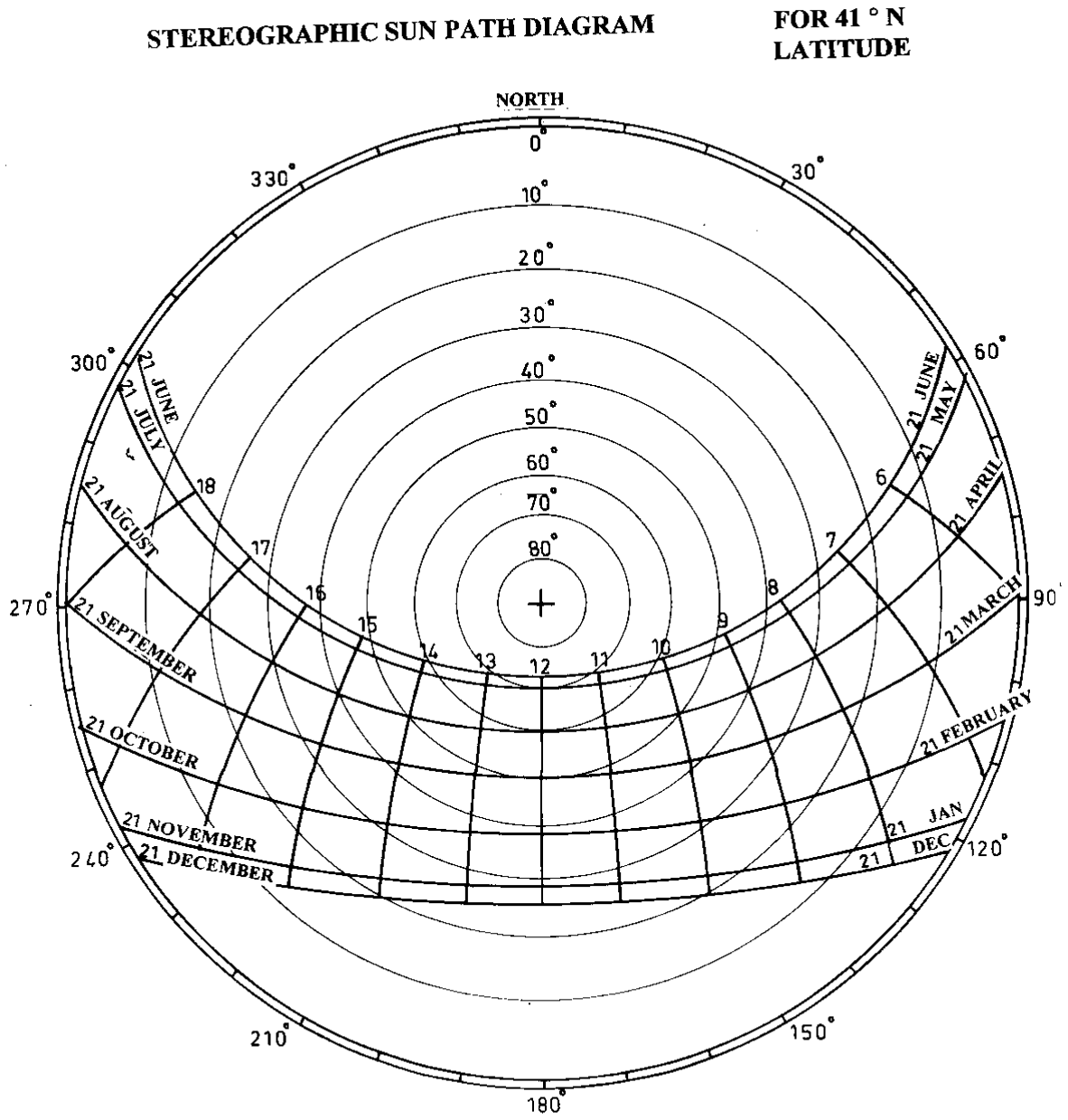


Figure 36.



Dr. Mesut Özdeniz

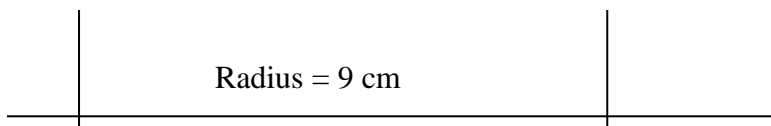
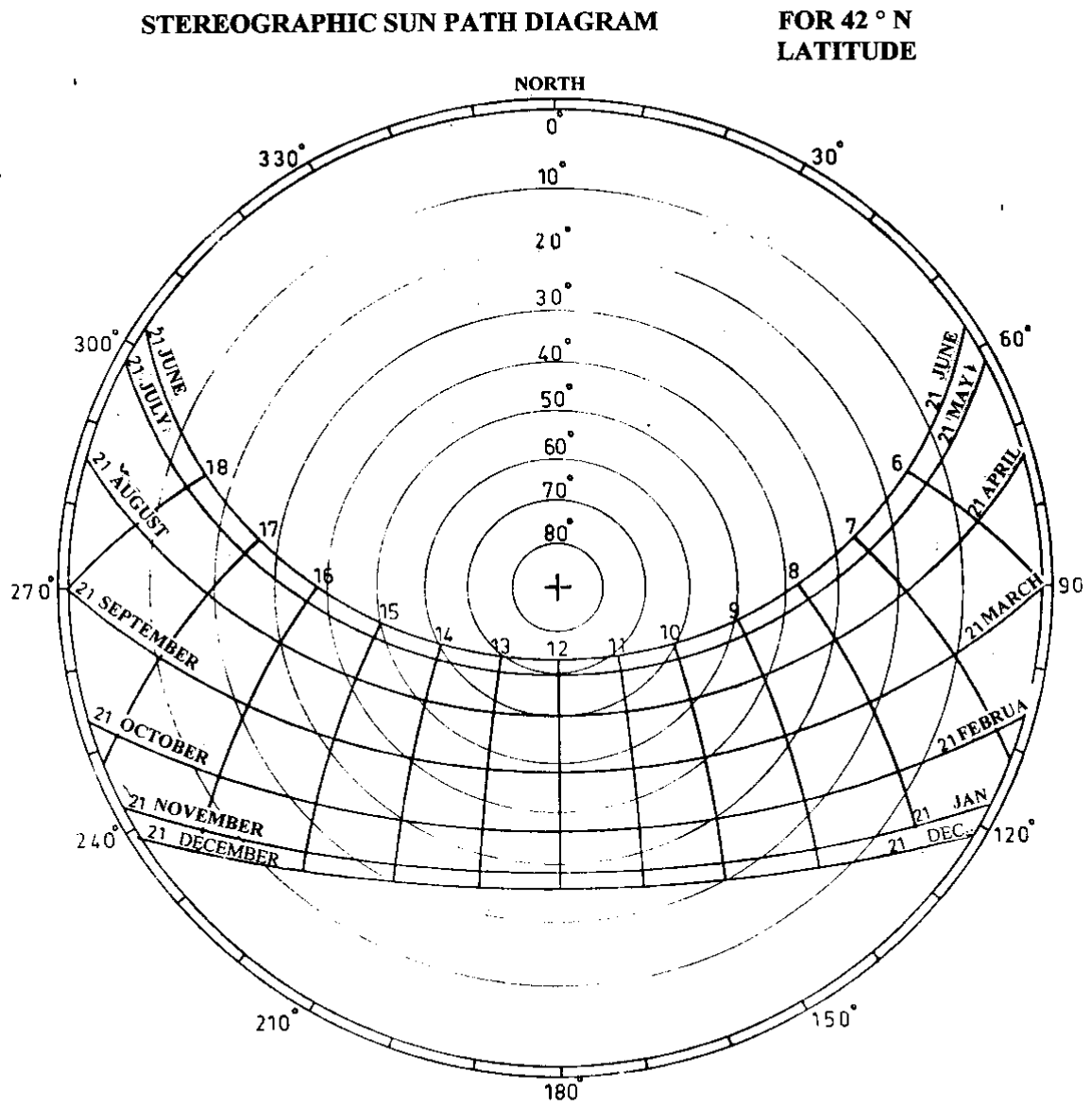




Figure 37.



Dr. Mesut Ozdeniz

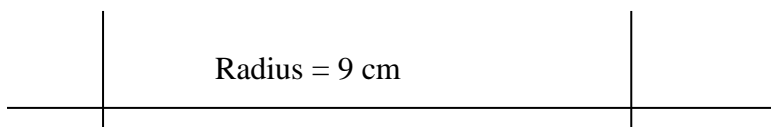
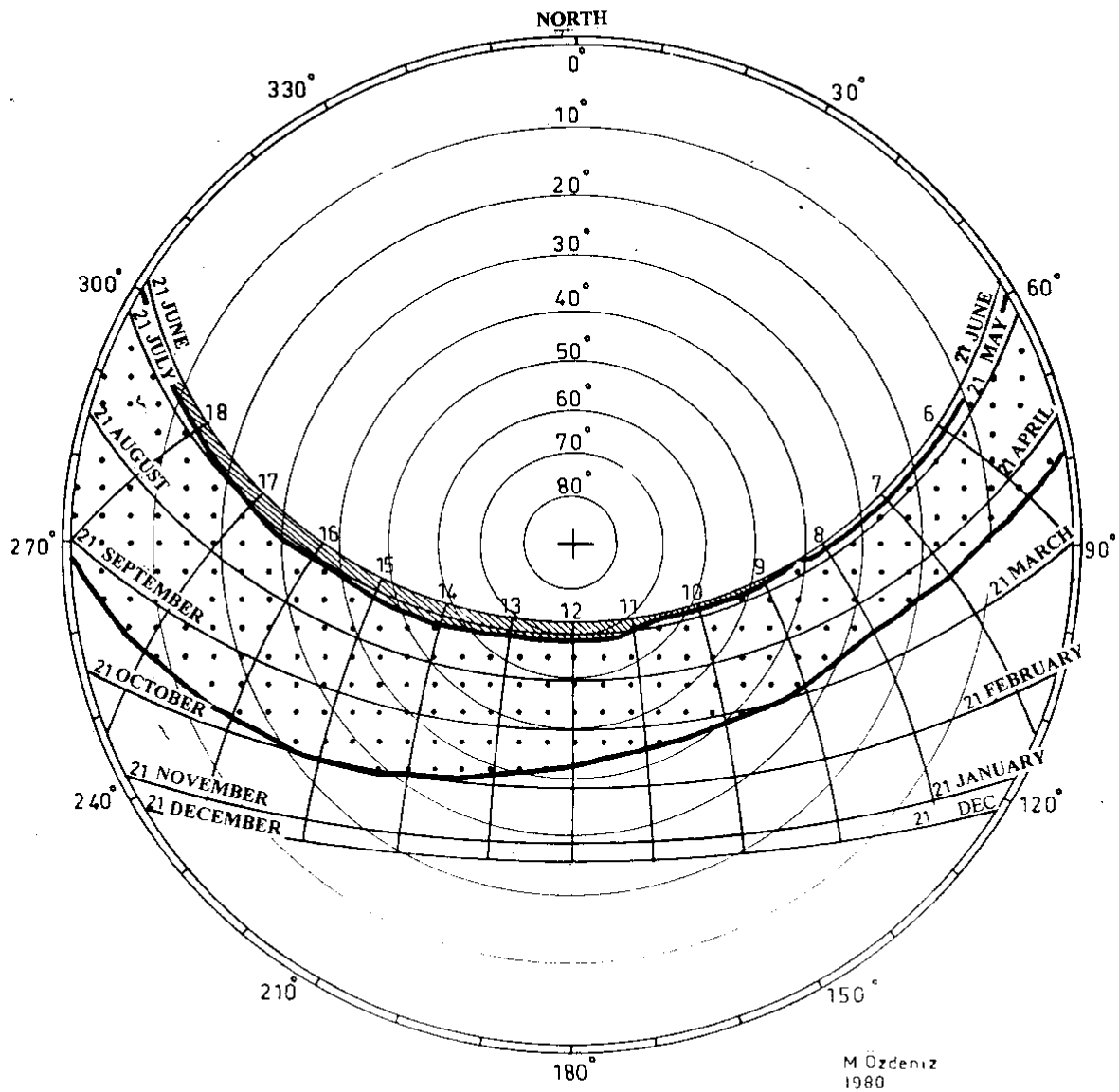


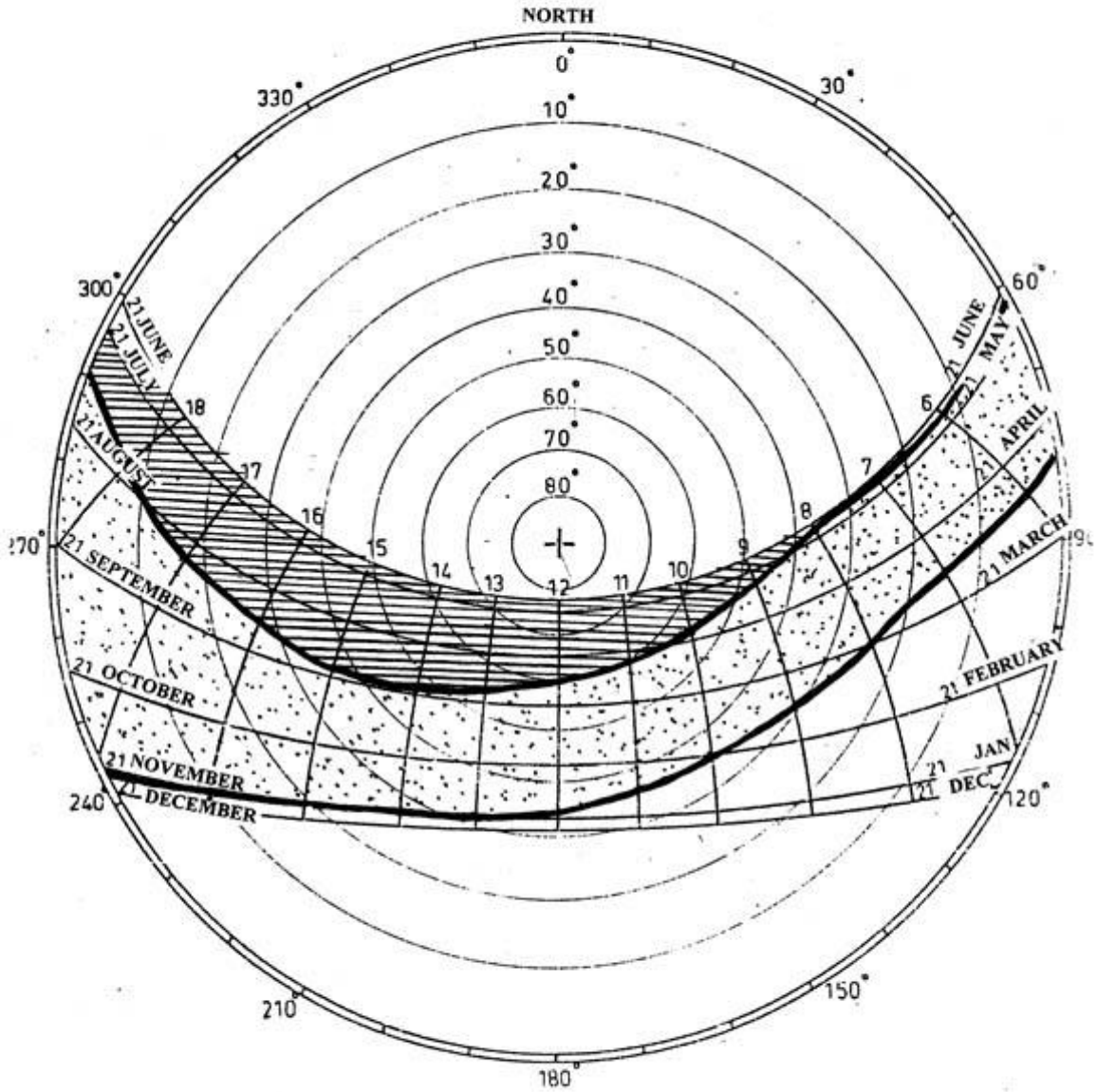
Figure 38.

**TRABZON SUN PATH DIAGRAM WITH THE OVERHEATED PERIOD**



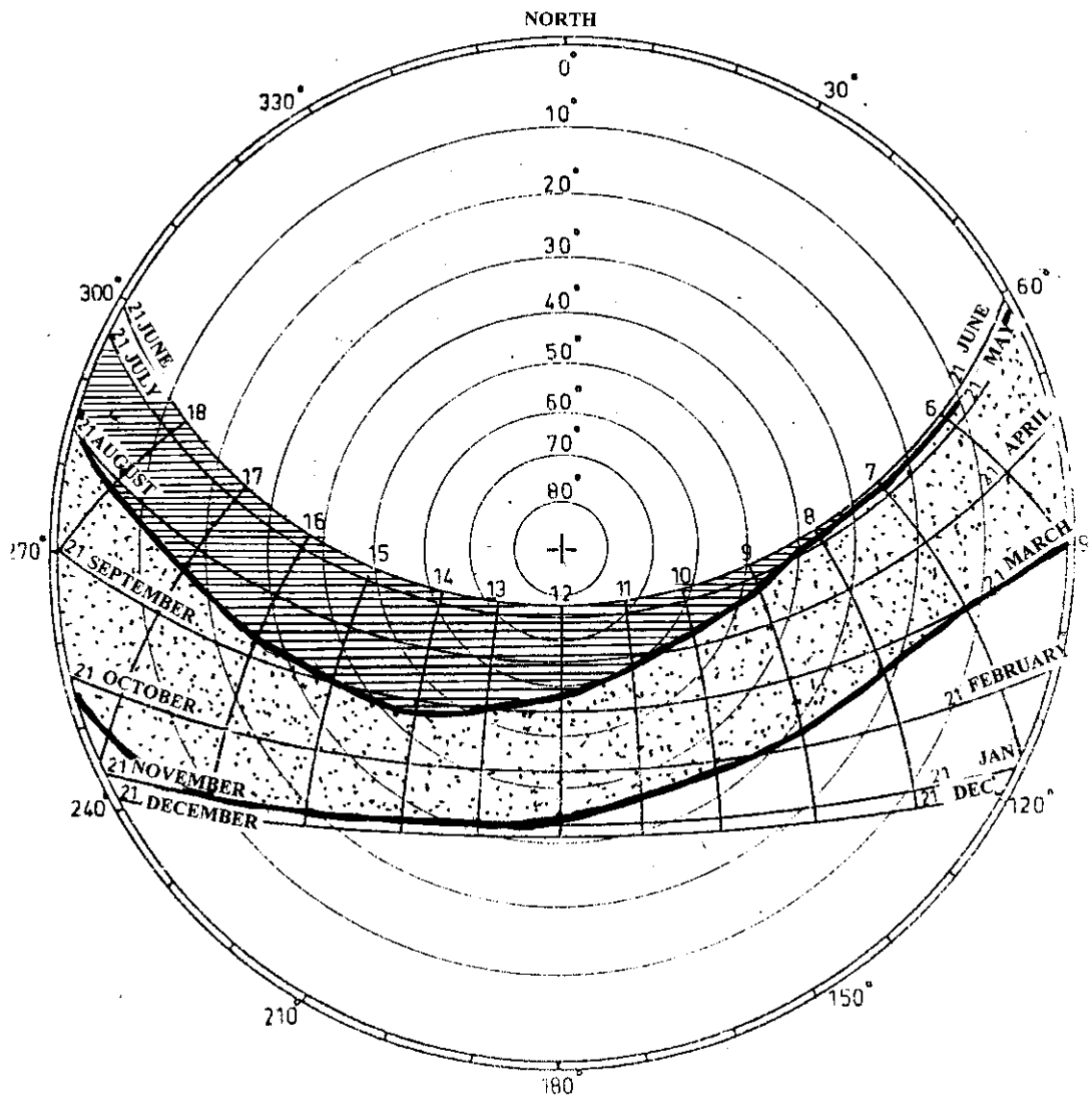
Radius = 9 cm

**LEFKOŞA**  
**SUN PATH DIAGRAM WITH THE OVERHEATED PERIOD**



**Prof.Dr. Mesut B. Özdeniz**  
**1999**

**GAZİMAĞUSA**  
**SUN PATH DIAGRAM WITH THE OVERHEATED PERIOD**



**Prof.Dr. Mesut B. Özdeniz**  
**1999**

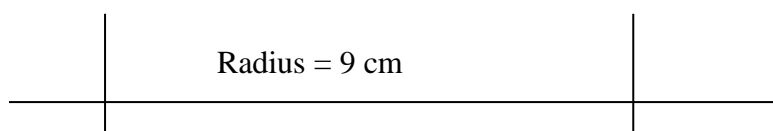
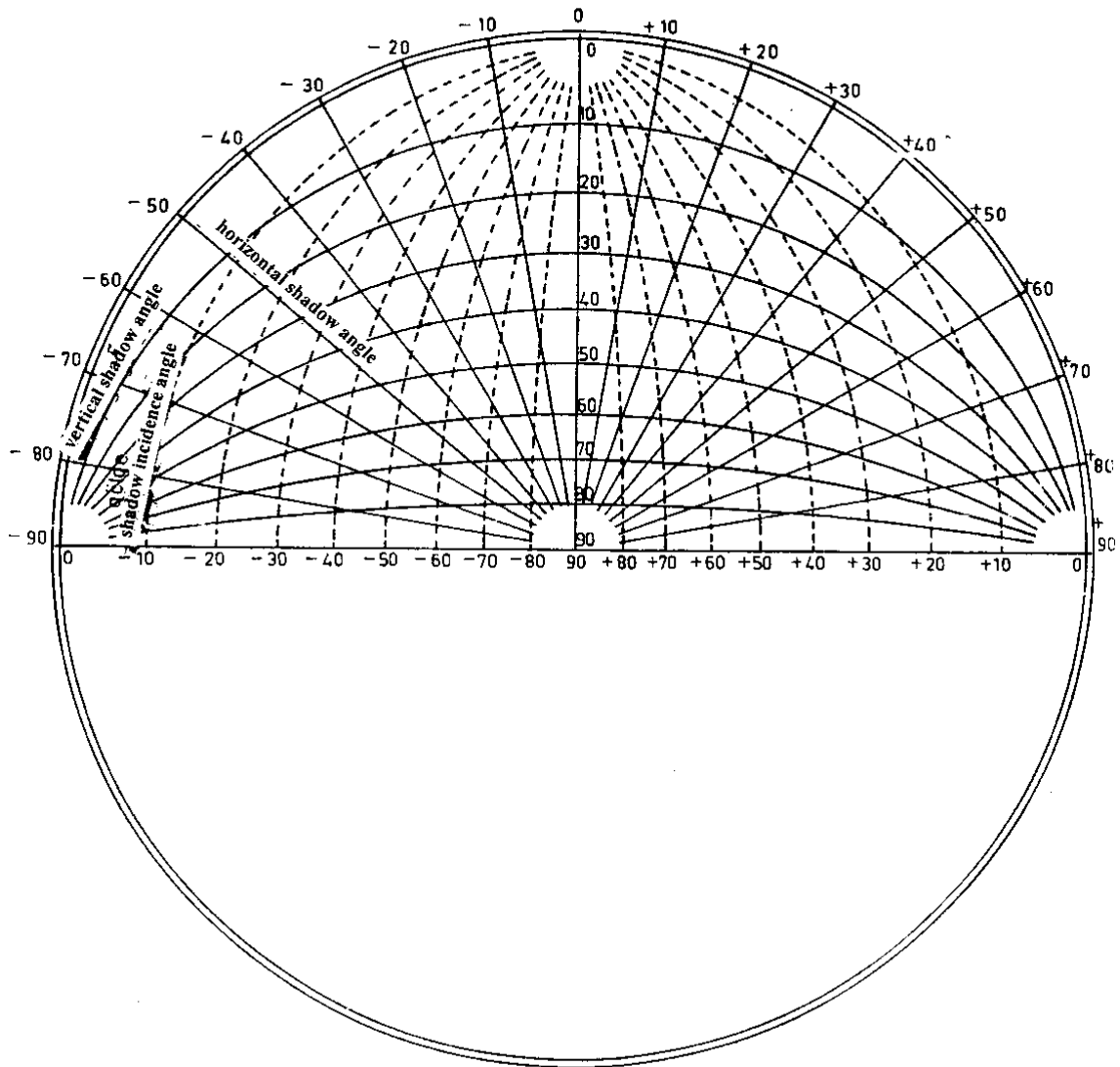


Figure 41.

**SHADOW ANGLE PROTRACTOR**  
(to be used with stereographic sun-path diagrams of the same size)



Radius = 9 cm

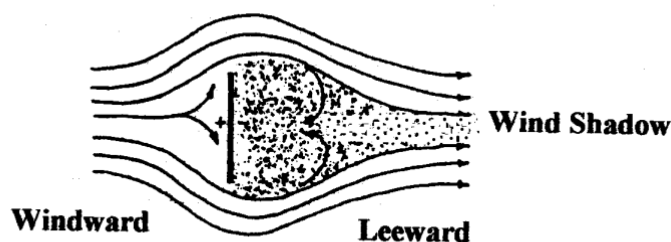
## 8. WIND CONTROL

Wind has different effects on human beings and buildings. One of its effects is “cooling”. Wind may cool human beings when dry-bulb temperature is below the deep body temperature. However if the relative humidity is very low and/or if the dry-bulb temperature is above the skin temperature wind will give discomfort. Wind will also give discomfort if the temperatures are too low. Because this time our body and the building will lose excessive heat. Another adverse effect of the wind is the building failure it may cause when the wind velocity exceeds 12 m/s.

When we use the Effective Temperature Charts with the wind roses we can decide from which winds we can benefit and which winds should be hindered. In hot-humid and temperate-humid climates during the times of excessive Effective Temperatures we should try to receive the winds in and around the buildings. In cool and temperate climates winds during the under heated period should be avoided.

In order to control wind we need to know how it moves around buildings and what is its effect. This is well explained with a theoretical case. Imagine a plate hanging in the air and a wind perpendicular to it is blowing. In this case the front part of this plate is called “Windward” and the back part will be called “Leeward”. At the front centre of the plate wind pressure will be maximum and this maximum pressure point will be called “Stagnation Point”. From the stagnation point the wind will move to the sides of the plate. At the sides of the plate wind velocity will increase but the pressure will be decreased. As the wind moves behind the plate it will draw the air on the leeward part. Thus there will be negative pressure or in other words suction behind the plate. Wind velocity will be reduced and there will be some gusts. The reduction of wind velocity is called “Wind Shadow”. After some distance behind the plate the wind will attain its original movement if there isn't any other barrier.

Figure 42. Air flow around a plate suspended in the air.



When the barrier is a building movement of wind around it and its effects will depend on the shape of the building. The following figures show some examples.

Figure 43. Airflow pattern around a rectangular building with a gabled roof.

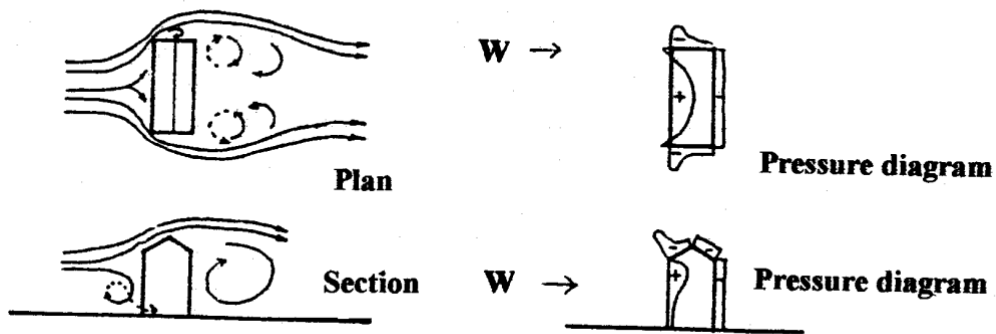


Figure 44. Air flow on a flat roof when the wind direction makes 45° angle with the building.

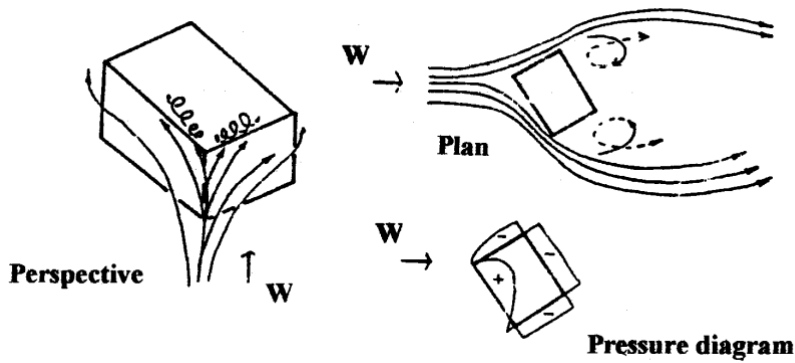


Figure 45. Air flow pattern around a gabled roof when the wind direction is perpendicular and makes 45° angle with the building.

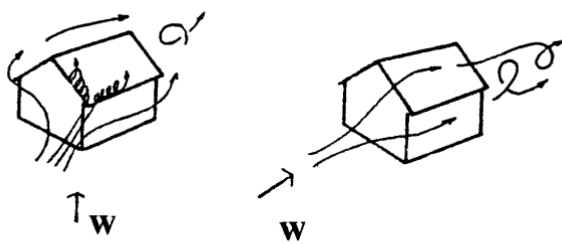


Figure 46. Air flow pattern around buildings of different height.

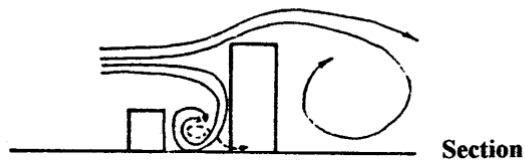


Figure 47. The effect of wind direction on wind shadow.

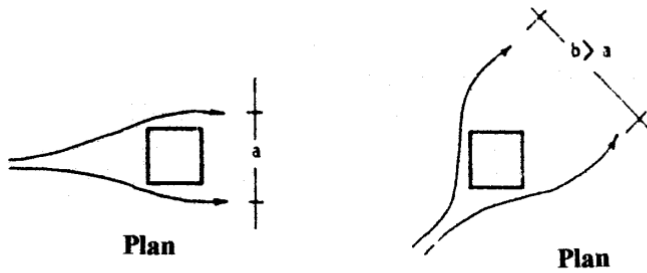


Figure 48. Airflow pattern around a building elevated on free columns.

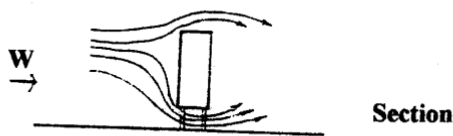


Figure 49. Tunnelling of wind between two buildings and the resultant wind pressure.

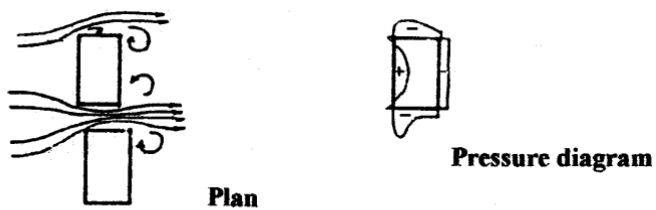


Figure 50. The effect of wind on horizontal projections.

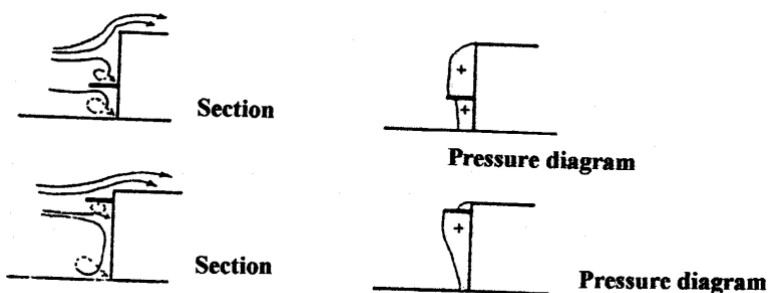




Figure 51. Airflow around L shaped buildings.

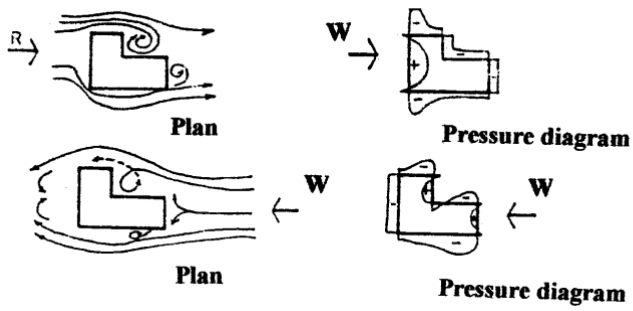


Figure 52. Airflow patterns between buildings.

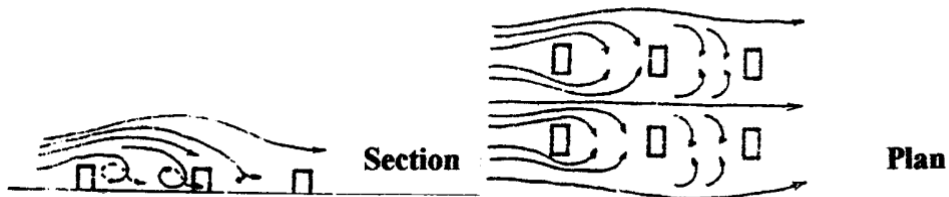


Figure 53. Two layout proposals to receive more wind.

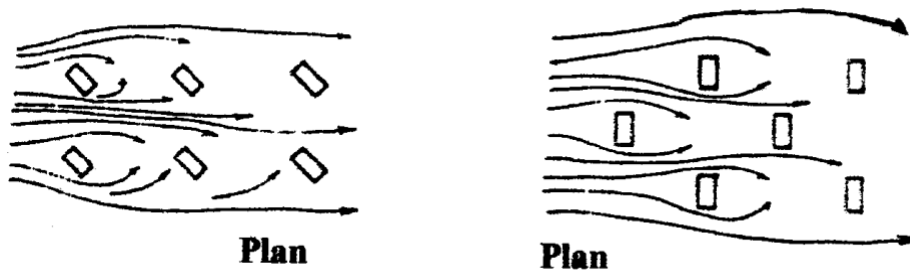
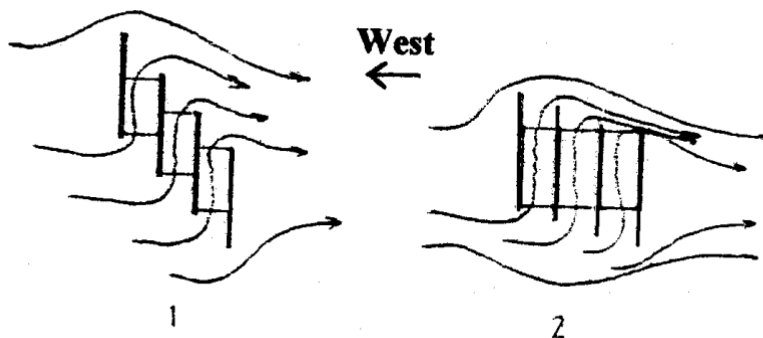


Figure 54. Two proposals to receive the west wind and exclude westerly solar rays.



## 9. NATURAL VENTILATION

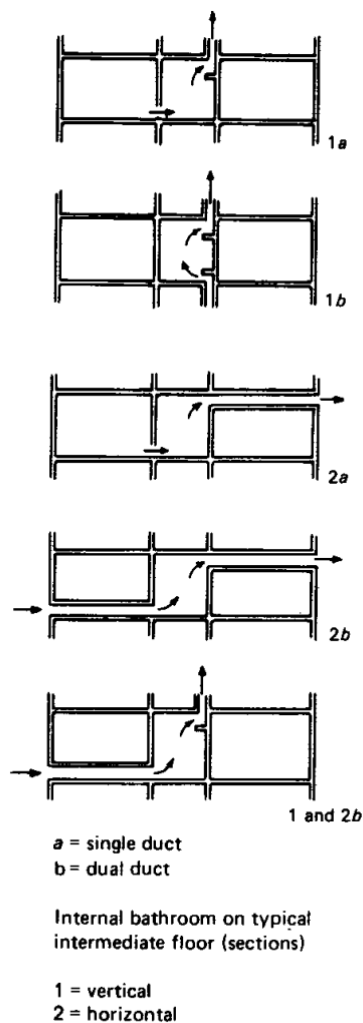
Natural ventilation is changing the used air of a room with fresh air without using any mechanical device.

When people breathe they use the oxygen in the air and discharge carbon dioxide. A normal person depending on the activity inhales 0.5 – 5.0 m<sup>3</sup>/hour air and changes 4% of it to carbon dioxide. Thus in close spaces with people in it carbon dioxide concentration increases. If carbon dioxide concentration of a space is more than 1% it is accepted as a badly ventilated enclosure. Different countries have somewhat different requirements of ventilations.

Ventilation does not only provide fresh air it also cools the inhabitants because an airflow passing around our body increases convectional heat loss and also evaporation of sweat.

In its simplest form natural ventilation can be achieved by cross ventilation, i.e. by opening the windows on opposing walls. In cool and temperate climates any small window can provide natural ventilation. In hot-humid and temperate-humid climates cross ventilation is necessary and in addition ventilation chimneys and channels may be needed.

Figure 55. Various arrangements of ventilation chimneys.

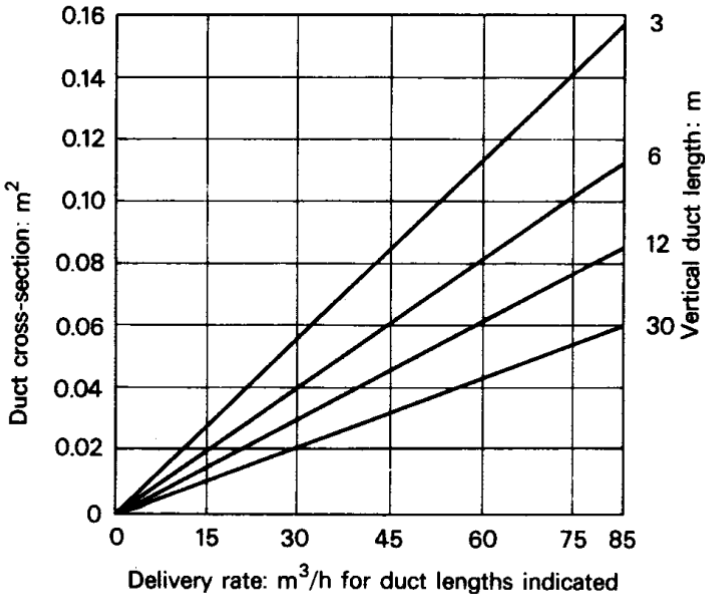


There are different arrangements of ventilation chimneys (Fig. 55). Ventilation rate through a chimney depends on the height, cross sectional area and the temperature difference between inside and outside air. The following equation shows the relation between these terms.

$$V_{\text{rate}} = 0.1715 A_{\text{chimney}} \sqrt{h_{\text{chimney}} (T_{\text{ia}} - T_{\text{oa}})}$$

- $V_{\text{rate}}$  : Ventilation rate,  $\text{m}^3/\text{s}$
- $A_{\text{chimney}}$  : Cross sectional area of the chimney,  $\text{m}^2$
- $h_{\text{chimney}}$  : Height of the ventilation chimney, m
- $T_{\text{ia}}$  : Internal air temperature,  $^{\circ}\text{C}$
- $T_{\text{oa}}$  : Outside air temperature,  $^{\circ}\text{C}$

Figure 56. Estimation of ventilation chimney cross section area.



## CLIMATIC DATA OF NORTH CYPRUS TOWNS

### GAZIMAGUSA

Location: 35° N Latitude 34° E Longitude

Height Above Sea Level: 7 m.

MONTHS	1	2	3	4	5	6	7	8	9	10	11	12	
Sunshine Period (Hour/day)	5.5	6.2	7.0	8.4	10.1	11.8	12.4	11.6	10.2	8.3	6.6	5.1	
Cloud Cover	6	5	5	4.5	4	2.5	2	1.5	2	3	4	5.5	
Solar Radiation Intensity W/ m <sup>2</sup>													
Total Solar Radiation (MJ/m <sup>2</sup> day)	7	10	14	18	23	24	24	23	18	14	9	6.5	
Mean Max Air Temperature (°C)	16.4	16.4	18.4	22.2	26.5	30.6	33.1	33.3	31.1	27.2	22.0	17.6	
Mean Min Air Temperature (°C)	6.9	6.5	7.8	10.5	14.2	18.4	21.1	21.4	16.4	15.3	11.0	7.5	
14.00Hours Relative Humidity (%)	60	60	57	52	48	47	45	46	48	52	55	60	
Mean Relative Humidity (%)	72.8	71.7	72.8	70.7	67.3	64.3	65.0	67.3	66.6	67.5	70.0	73.2	
7.00Hours Relative Humidity (%)	88	89	84	89	90	88	85	88	86	86	88	87	
Precipitation (Mm/month)	57.2	54.5	40.9	17.9	10.2	4.1	0.8	0.6	1.1	17.8	45.4	81.9	332
Predominant Wind Direction	W	W	W	W	W	SW	SW	SW	W	W	W	W	

### LEFKOŞA

Location: 35.2° N Latitude 33.5° E Longitude

Height Above Sea Level: m.

MONTHS	1	2	3	4	5	6	7	8	9	10	11	12	
Sunshine Period (Hour/day)	5.5	6.2	7.0	8.4	10.1	11.8	12.4	11.6	10.2	8.3	6.6	5.1	
Cloud Cover	6	5	5	4.5	4	2.5	2	1.5	2	3	4	5.5	
Solar Radiation Intensity(W/ m <sup>2</sup> )													
Total Solar Radiation (MJ/m <sup>2</sup> day)	9.3	12.4	16.2	20.6	24.2	26.7	26.2	23.9	20.9	16.6	10.9	8.7	
Mean Max Air Temperature (°C)	15.5	16.1	18.8	24.0	29.4	33.7	36.3	36.3	33.3	28.3	21.8	17.1	
Mean Min Air Temperature (°C)	5.3	5.2	6.6	9.9	14.5	18.7	21.6	21.3	18.4	14.6	9.7	6.6	
14.00Hours Relative Humidity (%)	53	48	42	32	30	28	26	27	28	38	44	50	
Mean Relative Humidity (%)	72.5	71.5	68.6	61.0	55.4	51.5	52.6	55.9	57.6	60.8	67.7	73.6	
7.00Hours Relative Humidity (%)	90	91	92	86	84	85	86	87	88	87	89	90	
Precipitation (Mm/month)	43.6	45.5	39.7	21.2	18.8	7.4	7.0	2.7	2.2	17.7	42.7	56.0	306
Predominant Wind Direction	W	W	W	W	W	W	W	W	W	W	W	W	

### GÜZELYURT

Location: 35.3° N Latitude 33° E Longitude

Height Above Sea Level: m.

MONTHS	1	2	3	4	5	6	7	8	9	10	11	12	
Sunshine Period (Hour/day)	5.5	6.3	7.1	8.6	10.2	11.9	12.0	11.2	10.0	8.1	6.6	5.2	
Cloud Cover	6	5	5	4.5	4	2.5	2	1.5	2	3	4	5.5	
Solar Radiation Intensity (W/ m <sup>2</sup> )													
Total Solar Radiation (MJ/m <sup>2</sup> day)	8.6	11.4	15.1	19.0	22.3	24.9	25.0	22.2	19.0	14.1	10.4	7.8	
Mean Max Air Temperature (°C)	16.4	16.6	19.0	23.4	27.6	31.5	33.9	33.8	31.4	27.5	22.4	17.9	
Mean Min Air Temperature (°C)	4.7	4.6	5.3	8.2	11.6	15.5	18.3	18.2	15.9	12.9	9.0	6.2	
14.00Hours Relative Humidity (%)	58	54	48	40	39	42	42	44	45	47	50	58	
Mean Relative Humidity (%)	75.8	73.7	73.2	66.5	63.3	61.7	61.8	64.2	64.7	65.2	70.5	76.6	
7.00Hours Relative Humidity (%)	90	88	87	86	85	84	85	87	88	89	90	91	
Precipitation (Mm/month)	48.2	49.4	39.2	21.4	8.4	4.7	0.4	1.7	2.9	18.1	37.7	52.8	284.9
Predominant Wind Direction	E	E	E	NW	W	NW	NW	NW	NW	E	E	E	

**GİRNE**

Location: 35.5 ° N Latitude 33.5 ° E Longitude

Height Above Sea Level: m.

MONTHS	1	2	3	4	5	6	7	8	9	10	11	12
Sunshine Period (Hour/day)	4.8	5.9	7.3	8.4	10.3	12.4	12.2	11.5	9.9	8.0	6.2	4.5
Cloud Cover	6	5	5	4.5	4	2.5	2	1.5	2	3	4	5.5
Solar Radiation Intensity (W/ m <sup>2</sup> )												
Total Solar Radiation (MJ/m <sup>2</sup> day)	8.7	12.3	16.6	20.3	24.2	26.9	26.2	23.0	19.4	14.5	10.2	7.6
Mean Max Air Temperature (°C)	15.8	15.9	17.8	21.2	25.1	29.2	32.3	32.4	30.3	26.5	21.3	17.5
Mean Min Air Temperature (°C)	8.5	8.0	9.2	11.8	15.1	19.1	22.0	22.2	20.4	17.0	13.0	10.0
14.00Hours Relative Humidity (%)	60	60	57	52	48	47	45	46	48	52	55	60
Mean Relative Humidity (%)	71.3	71.6	71.6	70.1	68.8	66.2	64.8	64.4	65.4	67.9	70.4	72.5
7.00Hours Relative Humidity (%)	88	89	84	89	90	88	85	88	86	86	88	87
Precipitation (Mm/month)	98.4	85.9	58.4	24.3	16.1	10.9	2.3	0.1	1.8	22.1	58.9	93.3
Predominant Wind Direction	S	S	S	W	W	W	W	W	W	W	SW	S

**CLIMATIC DATA OF AN UNKNOWN TOWN**

MONTHS	1	2	3	4	5	6	7	8	9	10	11	12
Sunshine Period (Hour/day)	4.0	5.0	5.8	7.5	9.5	12.8	13.0	12.2	10.5	7.8	6.0	4.0
Cloud Cover	7	6	6	5.5	4	2.5	2	1.5	2	3	5	6.5
Solar Radiation Intensity W/ m <sup>2</sup>	65	80	120	160	240	250	260	235	190	140	100	60
Total Solar Radiation (MJ/m <sup>2</sup> day)												
Mean Max Air Temperature (°C)	7.0	8.0	13.4	20.2	26.5	33.6	38.1	39.0	33.1	26.2	17.0	7.6
Mean Min Air Temperature(°C)	-1.9	0.0	3.0	7.5	11.2	14.0	20.1	21.0	17.4	10.3	3.0	-1.5
14.00Hours Relative Humidity(%)	63	60	50	42	38	20	18	18	20	28	50	66
7.00Hours Relative Humidity(%)	84	84	82	79	70	60	35	35	38	50	72	84
Precipitation (Mm/month)	80	70	60	70	40	10	1	1	2	30	55	70
Predominant Wind Direction												
Average days with snow cover	6	4	2	1	0	0	0	0	0	0	1	2
Average days with fog	3.5	2	0.5	0	0	0	0	0	0	0.5	2	3
Average days with severe winds	1.5	2	2.5	2.5	2.5	4	4	4.5	3.5	2.5	2	1.5
STATION : ???												
Location: 38 ° N Latitude 40 ° E Longitude												
Height Above Sea Level: 660 m.												

## **ENVIRONMENTAL CONTROL AND ACOUSTICS**

What is “environment”?

The simplest definition is, “Environment is all around me.”

A more scientific definition is, “Environment is the stimulus field that man senses and responds in some way.”

What are the boundaries of the environment?

It is not always easy to define the boundaries of the environment.

- . Tactile Environment. Touch requires direct contact
- . Olfactory Environment. Odours can be smelt at a distance of several hundred meters
- . Sonic Environment. Noise can be heard several kilometres away
- . Luminous Environment. We can see the light from distant stars.

We sometimes separate some of the relations of man with the environment and use special terms like:

- . Working environment
- . My environment
- . School environment
- . Social environment
- . Physical environment

Physical environment constitutes the relation of man with the physical phenomena in the environment, like;

- Light (visual relations)
- Sound (aural relations)
- Heat (thermal relations)

Environmental Control I ———→ Thermal relations are studied.

Environmental Control II ———→ Light and Sound (Lighting & Acoustics) will be studied.

### **1.1. WHAT WILL BE LEARNT IN ARCHITECTURAL ACOUSTICS ?**

When you graduate people will come to you with the following questions:

- There is too much noise coming from the flat above. What can we do?
- There is too much noise coming from the street. What can we do?
- There is too much noise within the building that we cannot understand the speech. What can we do?
- Lots of the workers in the factory are visiting the doctor with hearing defect. What can we do?
- At some parts of the auditorium we cannot hear the artists. What can we do?

These are some of the problems you will encounter and solve when you finish this course satisfactorily.

Acoustics is the science of sound. In acoustics two main subjects are studied.

- Noise Control
- Room Acoustics

Noise is unwanted sounds-or sounds which annoy.

Room Acoustics is a branch of acoustics which deals with good listening conditions.

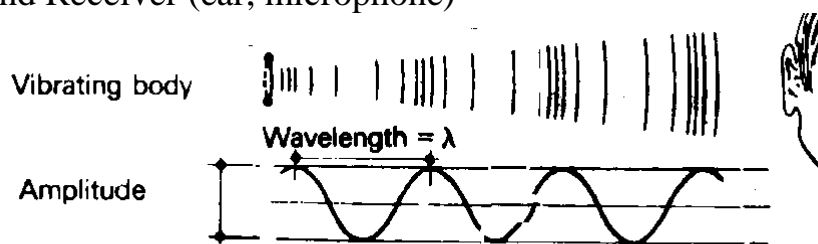
## 1.2. SOUND

There are two definitions of sound.

1. Sound is the pressure changes in an elastic medium caused by a vibrating body.
2. Sound is the sensation caused by a vibrating medium on the ear.

In a sonic environment there should be three components.

- . Sound Source (any vibrating body)
- . Elastic Medium (gas, liquid or solid)
- . Sound Receiver (ear, microphone)



**FIGURE 1.1. Explanation of sound propagation.**

$$v = f \cdot \lambda$$

Wavelength	( $\lambda$ )	meter
Frequency	( $f$ )	Hertz (Hz) = 1/s
Velocity	( $v$ )	m / s

Velocity of sound in air:

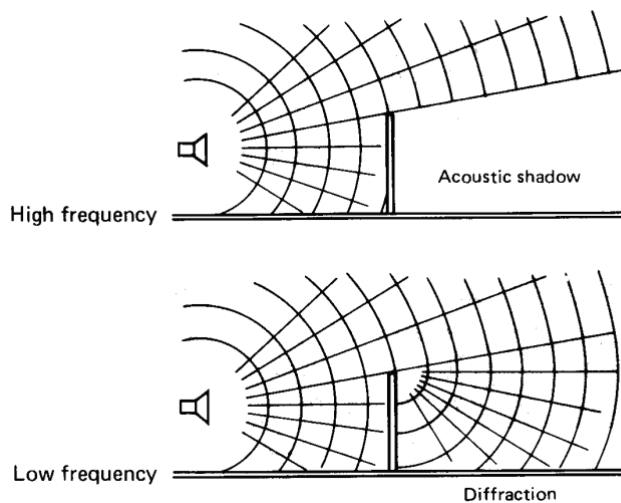
T= 14 °C, P= 1 atm	v= 340 m/s
T= 0 °C,	v= 331.8 m/s
T= 40 °C,	v= 353.3 m/s
Pure water	v= 1437 m/s
Sea water	v= 1440 m/s
Steel	v= 6100 m/s

### 1.2.1. ACOUSTIC SHADOW

Acoustic shadow explains the importance of frequency in acoustics. Other ones will be dealt later.

High frequency sounds are pitch sounds.

Low frequency sounds are bass sounds.



**FIGURE 1.2. Explanation of acoustic shadow.**

### 1.2.2. SOUND METRIC QUANTITIES

The quantities that measure the physical parameters of sound are called sound metric quantities. They are:

**SOUND POWER (W)** The output of a sound source which is measured as the rate of energy flow in units of watts (W).

Jet plain	10 000 W
Motorcycle	1 W
Talking	0.000 01 W

**SOUND INTENSITY ( I )** In the air, away from the sound source, the sound is measured as the density of energy flow rate through unit area, in  $W / m^2$  .

$$I = \frac{W}{4 \pi d^2}$$



SOUND PRESSURE ( P ) is the sound force acting on a unit area, in N/ m<sup>2</sup> = Pascal (Pa).

$$I = \frac{P^2}{\delta v} \quad \text{or} \quad P = \sqrt{I \delta v}$$

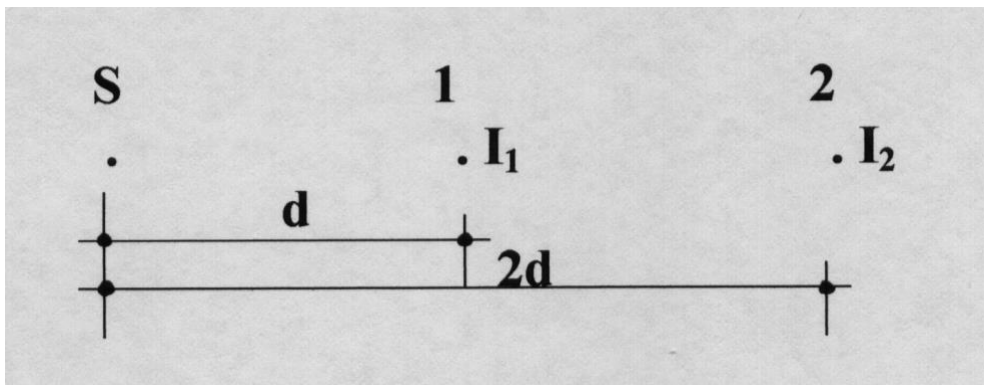
$\delta$  : density of the medium, kg / m<sup>3</sup>

$\delta v$  : acoustic impedance

For air at 14 °C ( $\delta= 1.18$  kg / m<sup>3</sup>,  $v=340$  m/s) acoustic impedance is 400 kg / m<sup>2</sup>

Thus;  $P = 20 \sqrt{I}$

### 1.2.3. SOUND LAWS



**Inverse square law:** If the distance from a sound source is doubled, sound intensity at point 2 will be one fourth of the sound intensity at point 1.

$$I_2 = \frac{I_1}{4}$$

**Law of additivity :** If the sound intensity of one source is  $I_1$  at a point and the sound intensity of the second source at the same point is  $I_2$ , the total intensity can be found by adding the two intensities.

$$I = I_1 + I_2$$

#### **1.2.4. SOME ACOUSTICAL TERMS:**

Airborne Sound

Structure borne Sound

Pure Tone Sound: Sound with just one frequency

Harmonics: Sounds which are the multiple frequencies of the basic frequency.

Harmonics are produced when the musical instruments are played.

The sound of piano has many harmonics. So it is called “Rich sound”.

The sound of flute has only one or two harmonics. So it is very close to pure tone sound.

Complex Sounds: Sounds with many frequencies in it are called complex sounds.

The sounds which we normally encounter in our daily life are complex sounds like human

voice, sounds of wind, motor vehicles, aeroplanes etc.

#### **1.3. HEARING**

Sound metric quantities explained during the last lecture are physical quantities with which sound is measured. As discussed in the definition, sound is also the sensation of the vibrations on the ear. Thus, it is necessary to know “HOW DO WE HEAR?”

Hearing depends on a series of mechanical events that transform sound waves in the air into electrical impulses in the nerves which are then carried to the brain.

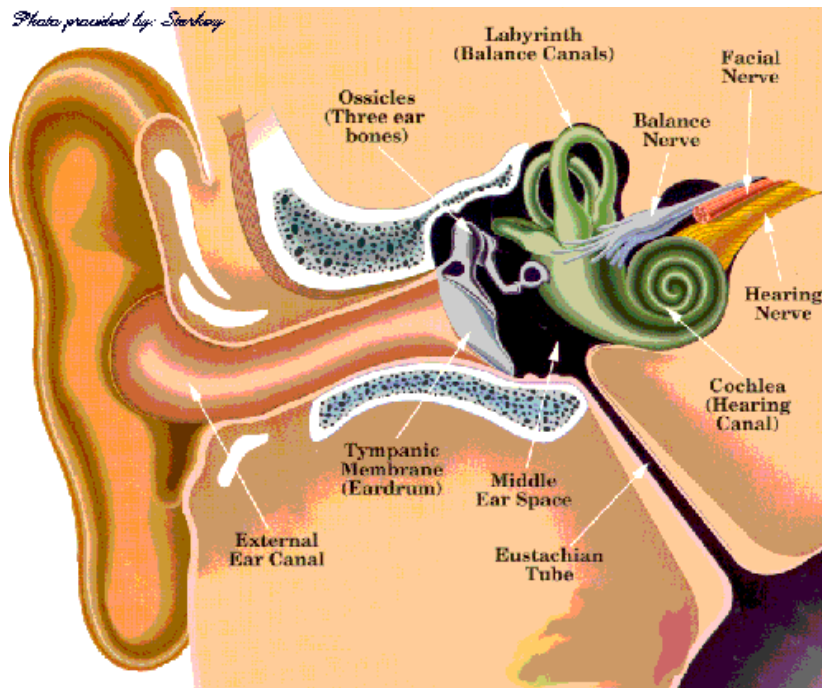
Human ear is composed of three parts.

1. Outer Ear: including the ear cup, ear canal and the eardrum
2. Middle Ear: including the ossicles (the three ear bones)
3. Inner Ear: including oval window, cochlea and the hearing nerves.

The sound waves first enter the ear through ear cup which collects and funnels them into the ear canal. At the end of the canal they hit the ear drum and vibrate it.

The ear drum in turn vibrates the three small bones of the middle ear. These bones called “ossicles” amplify the sound waves and react only to a certain frequency range because of their shapes. Ossicles send the vibrations to inner ear through the “oval window”. In the inner ear there is a snail shaped part called “cochlea” and filled with a fluid. The vibrations of this fluid are transmitted to the hair like hearing nerves. The vibrations in the fluid move these nerves and produce electrical signals which are then transmitted into brain.

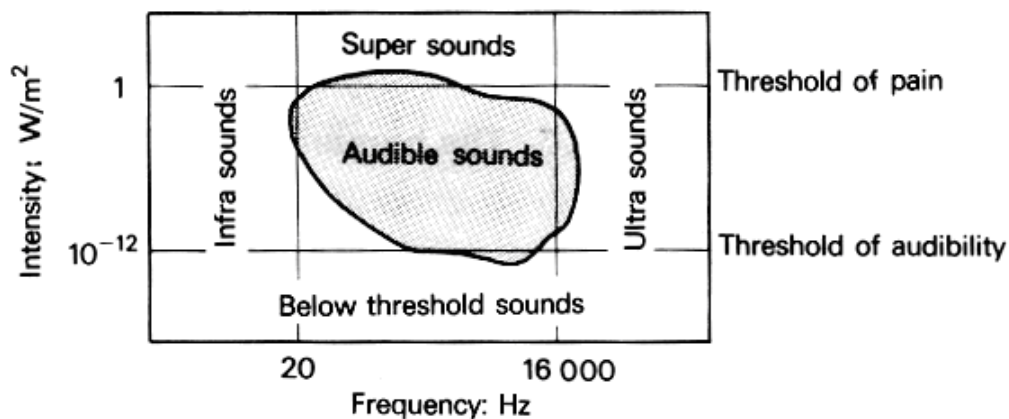
Sounds of different frequencies and intensities move the nerves in slightly different ways, thus allowing the brain to differentiate between sounds.



**FIGURE 1.3.** Section of human ear.

### 1.3.1. THE AUDIBLE SOUNDS

Hearing of sounds depend on many factors. However, sound frequency and sound intensity are the most important factors. Frequency determines the pitch of the sound perceived. Intensity determines the volume of the sound.



**FIGURE 1.4.** The audible sounds

### 1.3.2. SOUND INDEXES

Sound indexes are the quantities which measure hearing. There are many sound indexes in literature. Here we will study some of them.

#### 1.3.2.1. SOUND LEVEL (SL)

- . Sound Intensity Level (SIL)
- . Sound Pressure Level (SPL)

$$\text{SIL} = 10 \log \frac{I}{I_0} \quad (\text{dB})$$

$$I_0 = 1 \times 10^{-12} \text{ W / m}^2 \quad (\text{Threshold of hearing})$$

$$\text{SPL} = 20 \log \frac{P}{P_0} \quad (\text{dB})$$

$$P_0 = 2 \times 10^{-5} \text{ N / m}^2 \quad (\text{Threshold of hearing})$$

$$\text{SL} = \text{SIL} = \text{SPL}$$

SL is a good measure of hearing. So it is widely used. However, it has some setbacks too. So researchers tried to find better measures of hearing.

At 1000 Hz if SL is increased 10 dB it is heard twice louder. But this is not so for the other frequencies. When we work with SL we have give its frequency, otherwise it will be meaningless.

Octave Band: Small portions of the sound frequency range which we hear.

**TABLE 1.1. INTERNATIONAL STANDARD OCTAVE BANDS**

Frequency Range	Middle Frequency
22 - 44	31.5
44 - 88	63
88 - 177	125
177 - 354	250
354 - 707	500
707 - 1414	1000
1414 - 2828	2000
2828 - 5656	4000
5656 - 11312	8000

### 1.3.2.2. A WEIGHTED SOUND LEVEL ( $SL_{(A)}$ ), $dB_{(A)}$

In Weighted Sound Level a weighting is applied for different frequencies to obtain a better measure of hearing for different type sounds.

When a Weighted Sound Level is given, the frequencies are not mentioned. The weighting applied up to present are called A, B, C,D,E,SI weighting. Thus, the units of measurements with these weightings are called  $dB_{(A)}$ ,  $dB_{(B)}$ ,  $dB_{(C)}$ ,  $dB_{(D)}$ ,  $dB_{(E)}$  and  $dB_{(SI)}$  respectively.

The Weighted Sound Level which we will use mostly for many complex sounds is A Weighted Sound Level.

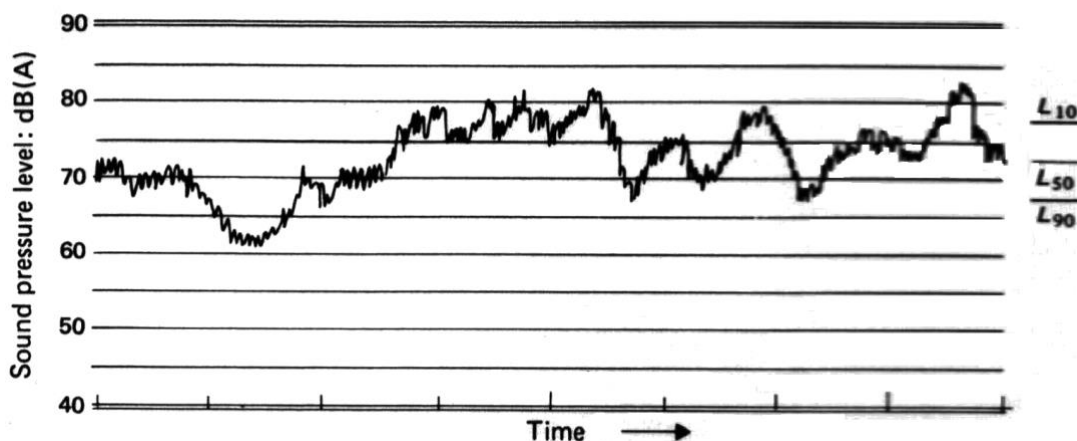
### 1.3.2.3. NOISE RATING (NR),

Noise Rating is another sound index which shows the maximum annoyance of a complex sound. At 1000 Hz Sound Level and the Noise Rating is same. However, at the other frequencies the value of SL and NR differ. (Fig. 1.6).

### 1.3.2.4. EQUIVALENT CONTINUOUS A WEIGHTED SOUND LEVEL ( $L_{eq}(A)$ ), $dB_{(A)}$

Most of the sound levels which we meet in our daily life are not constant. They show variation in time. Equivalent Continuous Sound Level is the average A Weighted Sound Level in a given time of an actually varying sound.

It is used for the analysis of noise at the settlement regions (community noise) and also for the evaluation of hearing loss.



**FIGURE 1.5 . An example of a sound level recording.**

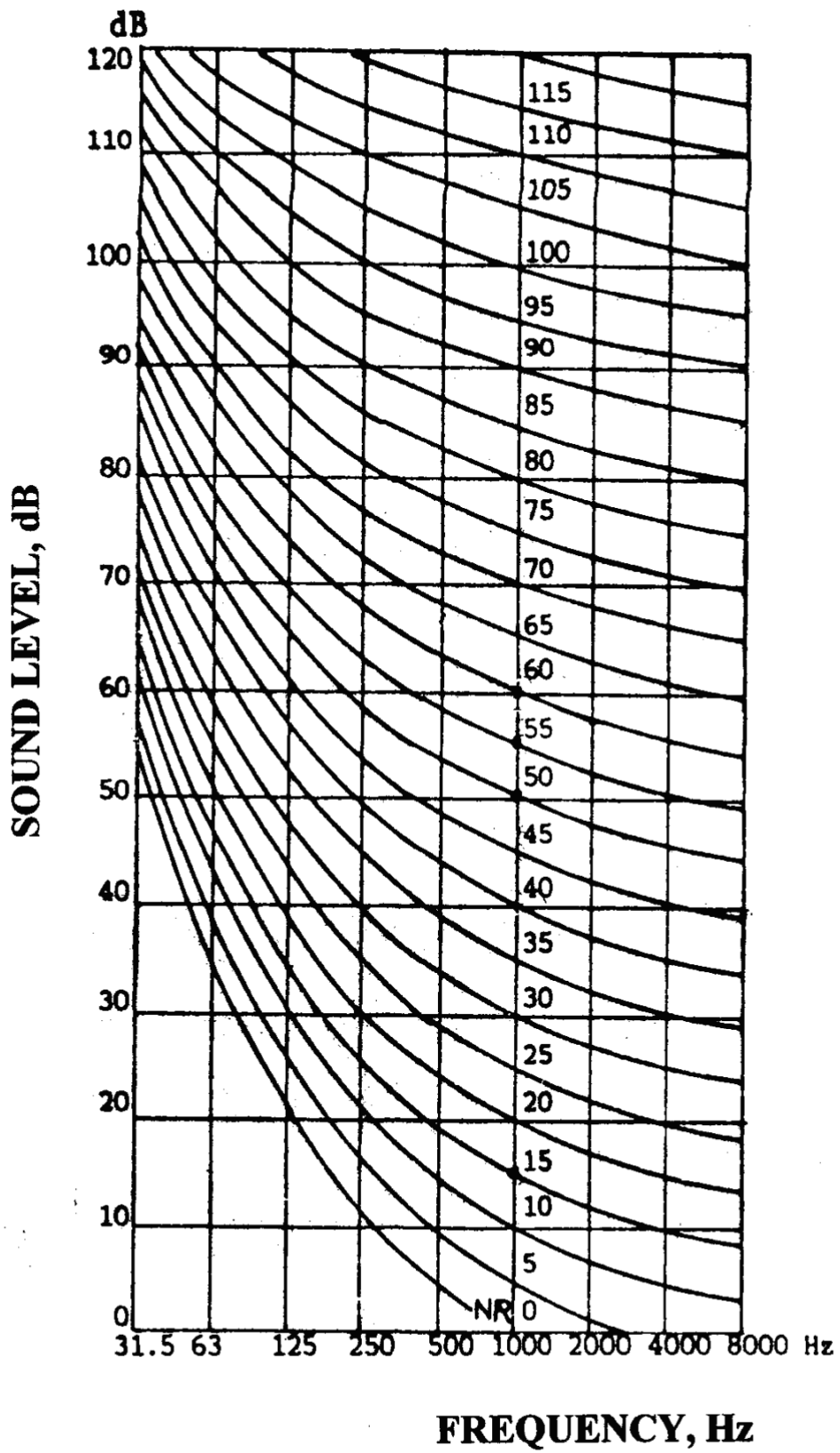


FIGURE 1.6. Noise Rating (NR) Curves.

### **1.3.3. THE EFFECTS OF SOUND ON MAN**

The sounds with random vibrations and unwanted sounds are called “noise” . If we take as A weighted sound level, between 0 – 50 dB(A) sounds do not annoy us. Sounds between 50-65 dB(A) can be tolerated for a short period. However, they may cause nervousness. Sounds above 65 dB(A) are unwanted sounds. To live with sounds of 90 dB(A) and over for many years may cause permanent deafness. To be exposed to 100 dB(A) for short time may cause temporary deafness, while long exposure may cause permanent deafness. 120 dB(A) will give pain and 150 dB(A) will cause instant deafness.

The sounds which we don't hear, also have some effect on us. Infra sounds (below 20 Hz) may cause dizziness, seasickness, disorientation, digestive disorders. 7 Hz vibrations will give headache and tiredness. 8 Hz vibration is the most dangerous one. It may trigger heart attack or burst some blood vessels. The reason why people living in crowded cities are more nervous is that they live in an environment which is exposed to infra sounds.

Sounds with frequencies above 16 000 Hz are ultra sounds. They are used in medical and industrial applications. They decay fast and do not have any adverse effect on man.

As people get old they loose their hearing. Loosing hearing do to age is called “Presbycusis”. This normally starts at the age of 20 and quite slow till 30. It accelerates afterwards. Presbycusis is not only due to ageing. Among the old people living at silent regions lower presbycusis has been seen. Presbycusis for higher frequency sounds is more in man, than in women.

## **1.4. SOUND CONTROL**

In order to control sound we should first know how much silent we should make the environment and the buildings. In other words we need to know the criteria.

### **1.4.1. CRITERIA FOR NOISE ANALYSIS**

There are different methods of analysing and evaluating noise. We may use any sound index for this purpose. For the community noise we may prefer to use  $L_{eq}$  (A) . If so, the basic criteria is 35 - 45 dB(A). This means; in the open spaces (outside the buildings)  $L_{eq}$  (A) should not be more than the basic criteria which is 35 – 45 dB(A). Noise Sensitive Areas in towns are areas near residences, hospitals, schools, motels, parks and the graveyards. In noise sensitive areas we should use the lower limit of the basic criteria which is 35 dB(A).

Please look at Table 1.2 for criteria of the other zones of the town, look at Table 1.3 for criteria for the different time of the day, and look at Table 1.4 for criteria of the internal spaces.

**TABLE 1.2 .The acceptable A Weighted Equivalent Continuous Sound Levels for the Environment in Terms of the Basic Criteria.**

ZONE NO	ZONE CHARACTERISTICS	Corrections on basic criteria $L_{eq} = 35 \sim 45 \text{ dB(A)}$
I	Out of town residence areas (away from the motor vehicle traffic)	0
II A	Suburban residence areas	+ 5
B	Urban residence areas (100 meter away from the motor vehicle traffic)	+ 10
C	Urban residence areas (60 meter away from the motor vehicle traffic)	+ 15
III	Downtown residences and commercial buildings (20 meter away from the motor vehicle traffic)	+ 20
IV	Industrial areas, main roads with heavy motor vehicle traffic	+ 25

At the NOISE SENSITIVE AREAS and for the future planning Basic Criteria is  $L_{eq} = 35$  .

**TABLE 1.3 . The correction of the Basic Criteria  $L_{eq} = 35 \sim 45 \text{ dB(A)}$  according to the time of the day.**

Time of the day	Basic Criteria Correction Factor
Day ( 06.00 - 19.00 )	0
Evening ( 19.00 - 22.00 )	- 5
Night ( 22.00 - 06.00 )	- 10



**Table 1.4 . The maximum permissible A weighted Equivalent Continuous Sound Levels for building interiors.**

Building Type	The Maximum Permissible $L_{eq}$ dB(A)
Leisure Buildings	
. Theatre Halls	25
. Conference Halls	25
. Hotel Bedrooms	30
. Hotel Restaurants	35
Health Buildings	
. Hospitals	35
Residences	
. Bedrooms	35
. Living Rooms (out of town)	40
. Living Rooms (Suburban)	45
. Living Rooms (Down town)	60
. Kitchens, Baths	70
Educational Buildings	
. Classrooms, labs	45
. Sports Halls, Dining Rooms	60
Commercial Buildings	
. Private Offices	50
. General Offices, Shops	60
Industrial Buildings	
. Small Factories	70
. Larger Factories	80

If we prefer to use Noise Rating the evaluation values of NR are given in table 1.5 and the criteria of internal spaces are given in Table 1.6.

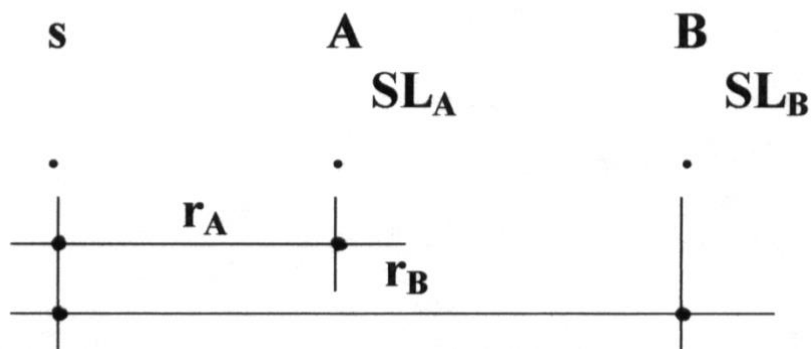
**Table 1.5 . Evaluation of the Noise Rating.**

Noise Rating (NR)	Its effect on human beings
20 - 25	Very silent
30 - 35	Silent
40 - 45	Somewhat noisy
50 - 55	Noisy
60 and over	Very noisy

**Table 1.6 . Maximum permissible noise rating inside the buildings.**

Building Type	Max. Permissible (NR)
Broadcasting Studios	15
Concert Halls	15
Theatres . Small	20
. Large	25
Music Rooms	20-25
TV Studios	20-25
Courtrooms, Conference Halls	25
Classrooms	30
Hospitals a) Bedrooms, Operations Halls	30
b) Dayrooms, Treatment Rooms, Clinics	35
Restaurants a) Small	35
b) Large	45
Shops	35
Superstores	40
Offices a) Manager's Room	20
b) 50 seat capacity Conference Hall	25
c) Private Offices, Reception	30
d) 15 seat capacity Conference Hall	35
e) General Offices	40-45
f) Type Writing, Printing Halls	50-55
Libraries	30
Residences	25-35
Hotels a) Luxury and first class	25
b) Second class	35
Laboratories, Drawing Halls	40-45
Corridors in buildings	40-45
Kitchens, Laundries, Schools, Workshops, Garages	45-55

#### 1.4.2. OUTDOOR SOUND CONTROL



**GEOMETRICAL REDUCTION OF SOUND.** Outside the buildings the best way of controlling sound is to get away from the sound source.

$$SL_B = SL_A - 20 \log \frac{r_B}{r_A}$$

**REDUCTION OF SOUND BY AIR MOLECULES.** If the distance is far enough in addition to the geometrical reduction air molecules also absorb sound. This depends mainly on the air temperature, air humidity and atmospheric pressure.

**TABLE 1.7 . Molecular absorption of sound in air in dB per 100 meters distance.**

Air Temperature ° C	Relative Humidity %	FREQUENCY, Hz			
		1 000	2 000	4 000	8 000
21	40	0.3	1.3	3.3	13
	60	0.3	0.6	1.6	8
	80	0.3	0.6	1.6	5
2	40	1.0	3.3	5	8
	60	0.6	1.6	5	13
	80	0.0	0.3	3.3	8

**REDUCTION OF SOUND BY GROUND COVER.** Trees and grass can absorb the sounds close to them if there is a considerable distance.

**TABLE 1.8 . Attenuation of sound due to ground cover in dB per 100 meters distance.**

Ground Cover	FREQUENCY							
	125	250	500	1000	2000	4000	8000	Hz
Short grass (20 cm)	0.5	-	-	3	-	-	-	
Long grass (40 cm)	0.5	-	-	12	-	-	-	
Pine Trees	7	11	14	17	19	20	-	
Deciduous Trees	2	4	6	9	12	16	-	

**TABLE 1.9 A simplified logarithmic table and some examples.**

<u>Number</u>	<u>Mantis</u>
1.0	0.000
1.25	0.097
1.50	0.176
1.75	0.243
2.00	0.301
2.25	0.352
2.50	0.398
2.75	0.439
3.00	0.477
3.25	0.512
3.50	0.544
3.75	0.574
4.00	0.602
4.25	0.628
4.50	0.653
4.75	0.676
5.00	0.699
5.25	0.720
5.50	0.740
5.75	0.760
6.00	0.778
6.25	0.796
6.50	0.812
6.75	0.829
7.00	0.845
7.25	0.860
7.50	0.875
7.75	0.890
8.00	0.903
8.25	0.916
8.50	0.929
8.75	0.942
9.0	0.954
9.25	0.966
9.50	0.977
9.75	0.989
<b>The basic characteristics of logarithm.</b>	
<b><math>\log A \cdot B = \log A + \log B</math></b>	
<b><math>\log A / B = \log A - \log B</math></b>	
<b><math>\log A_n = n \log A</math></b>	
<b>Examples:</b>	
$\log 4\ 820\ 000 = \log 4.82 \times 10^6 = 6.68$	
$\log 0.0000258 = \log (2.58 \times 10^{-5}) = 0.41 - 5$	
$\log 0.004657 = \log (4.657 \times 10^{-3}) = 0.66 - 3$	
$\log 1 = 0$	
$\log 10 = 1$	
$\text{Antilog } -2.7 = \text{Antilog } (0.3 - 3) = 2.0 \times 10^{-3}$	

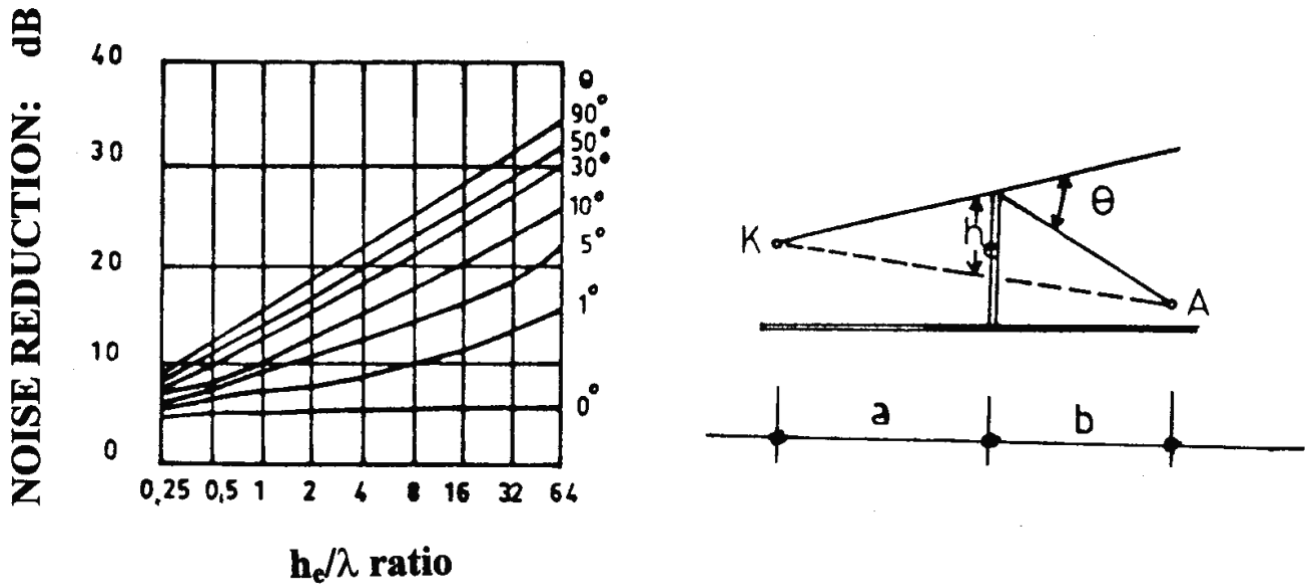


FIGURE 1.7. Reduction of noise by long walls.

### REDUCTION OF SOUND BY LONG ACOUSTIC BARRIERS

Long walls made of concrete, stone, earth, timber or even plastics or glass along the noisy highways can reduce the sound by reflecting it to the opposite direction. However, their performance increase if they are made of dense material and at the same time have sound absorptive elements on them. How much sound reduction can be achieved by long noise barriers can be found from the above graph or from the following equation.

$$D = 10 \log \sqrt{\frac{30 (f) (h_c)^2 (a+b)}{340 (a \cdot b)}}$$

D : Sound reduction in dB due to long noise barriers

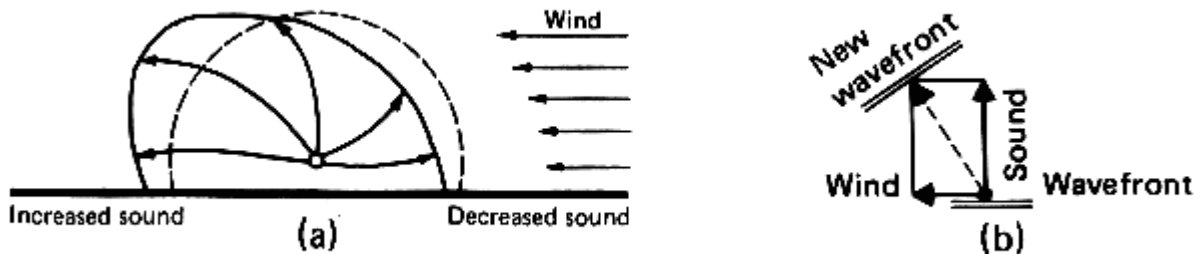


FIGURE 1.8. The effect of wind on sound.

**REDUCTION OF SOUND BY WIND.** Wind can reduce sound on the windward side of a sound source as explained in figure above.



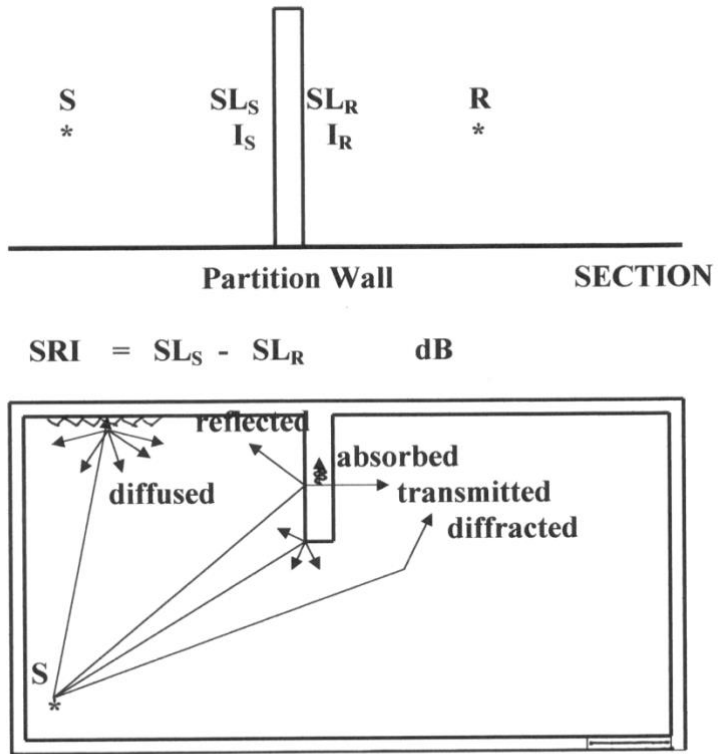
**Figure 1.9. Some examples of noise barriers.**

### **1.4.3. TERMS USED IN INDOOR SOUND CONTROL**

There are many terms used in indoor sound control. The most important ones will be dealt here.

#### **1.4.3.1. SOUND REDUCTION INDEX (SRI), dB**

Sound reduction index shows how much a partition element can reduce the sound passing to the other side. (Table 1.12)



**FIGURE 1.10. Definitions of some terms for indoor sound control.**

**TABLE 1.12 . Sound Reduction Index (SRI) of some constructions in dB.**

<b>TYPE OF CONSTRUCTION</b>	<b>Average</b>	<b>125</b>	<b>250</b>	<b>500</b>	<b>1000</b>	<b>2000</b>	<b>4000</b>
<b>Hz</b>							
<b>WALLS</b>							
1) 1/2 brick, plastered wall	45	34	36	41	51	58	62
2) 150 mm concrete wall	47	29	39	45	52	60	67
3) 1 brick, plastered wall	50	41	45	48	56	58	62
4) 1.5 brick, plastered wall	52	44	43	49	57	63	65
5) 130 mm hollow concrete blocks	46	36	37	44	51	55	62
6) 75 mm studs with 6 mm ply on both sides	24	16	18	26	28	37	33
7) 75 mm studs with 12 mm plasterboard	40	26	33	39	46	50	50
8) 75 mm staggered studs in 100 mm space with 6 mm ply on both sides	26	14	20	28	33	40	30
9) Double 1/2 brick, plastered, 50 mm cavity		40	43	50	57	63	68
10) 100 mm aerated concrete blocks		43	41	39	48	53	58
11) 200 mm aerated concrete blocks		34	39	42	49	54	56
12) 250 mm aerated concrete blocks		41	43	51	56	58	50
13) Double 75 mm aerated concrete panels with 50 mm glass wool in the cavity		34	41	43	58	66	80
<b>FLOORS</b>							
14) Timber floor with plasterboard ceiling	34	18	25	37	39	45	
45							
15) Same with floating boards on glass wool	42	25	33	38	45	56	
61							
16) Same as (14) with 75 mm rock wool on ceiling	39	29	34	39	41	50	
50							
17) Same as (15) with 75 mm rock wool on ceiling	43	27	35	44	48	56	
61							
18) Same as (15) with 50 mm sand	49	36	42	47	52	60	
64							
19) 125 mm reinforced concrete	45	35	36	41	49	58	
64							
20) Same as 19 with floating screed	50	38	43	48	54	61	
65							
<b>WINDOWS</b>							
21) 3 mm single glazed window	22	17	21	25	26	23	26
22) 6 mm single glazed window with gaskets	25	28	30	34	24	35	
23) Double, 4 mm glass, 200 mm space absorbent reveals	39	30	35	43	46	47	37
24) Same as (23) with 10 mm glass	44	31	38	43	49	53	63
<b>DOORS</b>							
25) 50 mm solid timber, normally hung	18	12	15	20	22	16	24
26) Same as (25) with airtight gaskets	22	15	18	21	26	25	28
27) 50 mm hollow core, normally hung	15	14	19	23	18	17	21
28) Same as (27) with airtight gaskets	20	19	22	25	19	20	29
29) Double 50 mm solid timber, airtight gaskets, absorbent lobby	45						



**TABLE 1.13 . Sound Absorption Coefficient (K<sub>a</sub>) of some surfaces.**

Surfaces	Sound Absorption Coefficient (K <sub>a</sub> )						
	125	250	500	1000	2000	4000	8000 Hz
<b>WALL SURFACES</b>							
Exposed brick wall	0.024	0.025	0.032	0.041	0.049	0.07	0.09
Plastered brick wall 15 cm	0.01	0.05	0.05	0.05	0.06	0.06	0.06
Plastered hard brick wall	0.10	0.13	0.15	0.04	0.05	0.04	0.05
Painted concrete block	0.10	0.05	0.06	0.07	0.09	0.08	0.07
Unpainted concrete block	0.36	0.44	0.31	0.29	0.39	0.25	
Unpainted cast-in-situ concrete	0.01	0.01	0.02	0.02	0.02	0.03	
Wall finished with glass, ceramic or marble	0.01	0.01	0.01	0.01	0.015	0.02	0.04
10-13 mm thick timber panel in front of 50-100 mm air cavity	0.30	0.25	0.20	0.17	0.15	0.10	
Boarding on 20 mm battens on solid wall	0.30		0.10		0.10		
Tooled stone wall	0.02		0.02		0.05		
13 mm gypsum board on 50/100 mm battens	0.29	0.10	0.05	0.04	0.07	0.09	
6 mm plywood, 75 mm air cavity, 25 mm glass wool	0.60	0.30	0.10	0.09	0.09	0.09	
25 mm cork tiles on solid backing	0.06		0.20		0.60		
<b>FLOORINGS</b>							
Concrete or terrazzo	0.01	0.01	0.02	0.02	0.02	0.03	0.06
Linoleum on concrete	0.02	0.03	0.03	0.03	0.03	0.02	0.05
Timber parquet flooring on concrete	0.04	0.04	0.07	0.06	0.06	0.07	0.10
Marble or ceramic flooring	0.01	0.01	0.01	0.01	0.015	0.02	0.04
1.35 kg/m <sup>2</sup> density carpet or rubber foam on concrete	0.08	0.24	0.57	0.69	0.71	0.73	
Timber floor	0.15	0.11	0.10	0.07	0.06	0.07	0.09
Timber floor with air cavity underneath	0.40	0.30	0.20	0.17	0.15	0.10	
<b>WINDOWS</b>							
Window with 4 mm thick glass	0.13	0.06	0.04	0.03	0.02	0.02	
Wide windows with thicker glass	0.18	0.06	0.04	0.03	0.02	0.02	
<b>CURTAINS</b>							
Heavy curtain 0.34 kg/m <sup>2</sup>	0.03	0.04	0.12	0.18	0.25	0.35	0.30
Heavy curtain 0.45 kg/m <sup>2</sup>	0.07	0.30	0.50	0.75	0.70	0.60	0.55
Heavy curtain 0.60 kg/m <sup>2</sup>	0.15	0.35	0.55	0.73	0.70	0.65	0.60
<b>CARPETS</b>							
Thick hairy carpet	0.15	0.20	0.35	0.40	0.50	0.60	0.55
Carpets with 3 mm long fibres	0.05	0.05	0.10	0.20	0.30	0.40	0.35
Carpets with 5 mm long fibres	0.05	0.10	0.10	0.30	0.40	0.50	0.45
Carpets with 7 mm long fibres	0.05	0.10	0.16	0.31	0.50	0.55	0.50
Carpets with 8 mm long fibres	0.05	0.15	0.30	0.40	0.50	0.60	0.55
Woollen carpet	0.06	0.20	0.41	0.60	0.70	0.65	0.60
Cotton carpet	0.03	0.04	0.11	0.17	0.20	0.35	0.40
<b>CEILINGS</b>							
Acoustical celluloid tiles on suspended ceiling	0.42	0.49	0.65	0.74	0.71	0.52	
The same glued on solid ceiling	0.10	0.29	0.57	0.70	0.68	0.47	
Plaster or plasterboard ceiling, large air space	0.20		0.10		0.04		

**TABLE 1.13 . (continued)**

Surfaces	Sound Absorption Coefficient (K <sub>a</sub> )						
	125	250	500	1000	2000	4000	8000 Hz
<b>COMMON ABSORBERS</b>							
Plywood 5 mm thick	0.57	0.23	0.07	0.04	0.03	0.07	0.09
Cedar wood	0.25	0.20	0.05	0.08	0.14	0.10	0.12
Rough surfaced gypsum plaster	0.02	0.03	0.04	0.05	0.04	0.03	0.03
Smooth surfaced gypsum plaster	0.02	0.015	0.02	0.035	0.04	0.04	0.05
Gypsum or lime plastered brick wall	0.013	0.015	0.02	0.03	0.04	0.05	
Same on concrete block backing	0.12	0.09	0.07	0.05	0.05	0.40	
Plaster on lath, air space, solid backing	0.30	0.15	0.10	0.05	0.04	0.05	
Glass wool 100 mm	0.32	0.40	0.51	0.60	0.65	0.65	0.60
Polyester	0.05	0.16	0.42	0.36	0.20	0.20	0.20
Glass wool and plastering	0.35	0.50	0.70	0.80	0.85	0.90	0.90
Plywood or timber on 45 mm battens and solid backing	0.30		0.15		0.10		
Same with glass wool in the cavity	0.40	0.30	0.15	0.09	0.09	0.09	
25 mm sprayed asbestos on solid backing	0.15		0.50		0.70		
25 mm glass wool on solid backing, open mesh cover	0.15		0.70		0.90		
Same with 5% perforated hardboard cover	0.10		0.85		0.35		
Same with 10% perforated or 20% slotted hardboard cover	0.15		0.75		0.75		
50 mm glass wool on solid backing, open mesh cover	0.35		0.90		0.95		
Same with 10% perforated or 20% slotted hardboard cover	0.40		0.90		0.75		
3 mm hardboard, bituminous felt backing on 50 mm air space and solid backing	0.90		0.25		0.10		
<b>AIR</b>							
Per cubic meter air at 50% relative humidity	0		0	0.003	0.007	0.024	
<b>SEATS</b>							
Seat, unoccupied, upholstered	0.24	0.27	0.29	0.33	0.37	0.40	0.39
Seat, unoccupied, wooden, padded	0.15	0.20	0.25	0.30	0.01	0.35	0.30
<b>HUMAN BODY</b>							
Audience (per m <sup>2</sup> )	0.36	0.42	0.45	0.45	0.45	0.45	0.45
Musician with the seat and the instrument (per musician)	0.40	0.85	1.15	1.40	1.30	1.20	
Audience in upholstered seats (per person)	0.186		0.465		0.51		
Audience in wooden or padded seats (per person)	0.158	0.28	0.40	0.40	0.436		
<b>THE OTHER SURFACES</b>							
Open water surface (per m <sup>2</sup> )	0.01	0.01	0.01	0.01	0.02	0.03	0.03
NOTE : When shaded by seats sound absorption coefficient of the floor should be reduced 20% at 125 Hz, 30% at 250 Hz, 40% at 500 Hz, 50% at 1000 Hz, and 60% at 2000 Hz.							

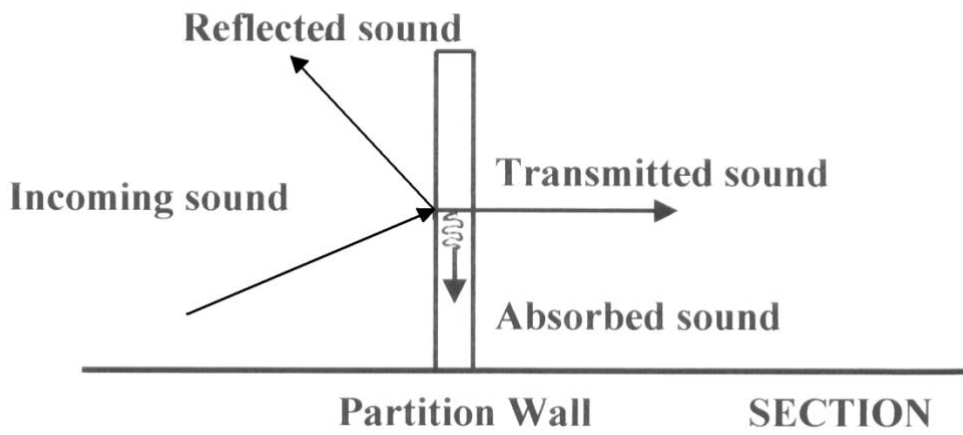
### Prediction of SRI:

$$\text{SRI} = 18 \log \rho_s + 12 \log f - 25$$

SRI: Sound reduction index

$\rho_s$  : Surface density, kg / m<sup>2</sup>

f : frequency, Hz



**FIGURE 1.11. Definitions of some sound coefficients.**

#### 1.4.3.2. SOUND ABSORPTION, REFLECTANCE AND TRANSMISSION

When sound wave hits a partition element it may be reflected, transmitted or absorbed by the partition.

Sound Reflectance ( $\rho_s$ ) is the ratio of the reflected sound to the incoming sound. “ses yansıtma katsayısı”

Sound Absorbance ( $\alpha_s$ ) is the ratio of the absorbed sound to the incoming sound. It is also the fraction of the sound energy converted to heat. “ses emme katsayısı”

Sound Transmittance ( $\tau_s$ ) is the ratio of the transmitted sound to the incoming sound. It is also ratio of sound intensity on the receiver side to the sound intensity on the source side of the partition element. “ses geirme katsayısı”

### 1.4.3.3. RELATIONS BETWEEN THE TERMS

$$\tau_s = \frac{I_R}{I_s}$$

$$SRI = 10 \log \frac{1}{\tau_s} = 10 ( - \log \tau_s )$$

$$\tau_s = \text{antilog} \left( \frac{-SRI}{10} \right)$$

Sound reflectance, absorbance, transmittance:

$$\rho_s + \alpha_s + \tau_s = 1.0$$

Sound Absorption Coefficient ( $K_a$ ), “Ses Yutma Katsayısı” Sound absorption coefficient is the ratio of all the sounds which are not reflected at a partition to the incoming sound. (TABLE 2.11)

Sound Absorption ( $K_A$ ) is the product of surface area  $A$  in  $m^2$  and sound absorption coefficient ( $K_a$ ).

$$K_A = K_a \times A$$

Total Sound Absorption ( $\Sigma K_A$ ) “Toplam Yutulma”

$$\Sigma K_A = \Sigma ( K_a \times A )$$

Average Absorption Coefficient, “Ortalama Ses Yutma Katsayısı”

$$\overline{K_a} = \frac{\Sigma K_A}{\Sigma A}$$

### 1.4.3.4. REVERBERATION TIME, (RT) “Çınlama süresi”

$$RT = 0.16 \frac{V}{\Sigma K_A} \quad (\text{Sabine equation for small halls})$$

$$RT = 0.16 \frac{V}{A_{is} \left[ 2.31 \log (1 - \overline{K_a}) \right]} \quad \text{Norris-Eyring equation for large and sound absorptive halls}$$

RT : Reverberation time, seconds

V : Volume of the room,  $m^3$

$\Sigma K_A$ : Total sound absorption of the room,  $m^2$

$A_{is}$  : Total interior surface area,  $m^2$

$\overline{K_a}$  : Average sound absorption of the room,  $m^2$  .

It is very important in acoustics to understand the difference between Sound Reduction Index (SRI) and Sound Absorption Coefficient ( $K_a$ ). Sound Reduction Index shows sound insulation. Sound Absorption Coefficient shows percentage of sounds which are not reflected. Some surfaces may have very bad SRI but very good  $K_a$  and vice versa, or they may be good in both of them. We use them accordingly. For example an open door has hundred percent  $K_a$  but zero SRI.

#### 1.4.3.5. Area Weighted Average SOUND REDUCTION INDEX, $(\overline{SRI})$ and Area Weighted Average SOUND TRANSMISSION, $(\overline{\tau_s})$

If a wall is made of two or more elements with different SRI then the area weighted average SRI is found. We cannot add the SRI of each wall. So first we find the Sound Transmission of each element and then the Area Weighted Sound Transmission. Later it can be converted to Area Weighted Average SRI.

#### EXAMPLE :

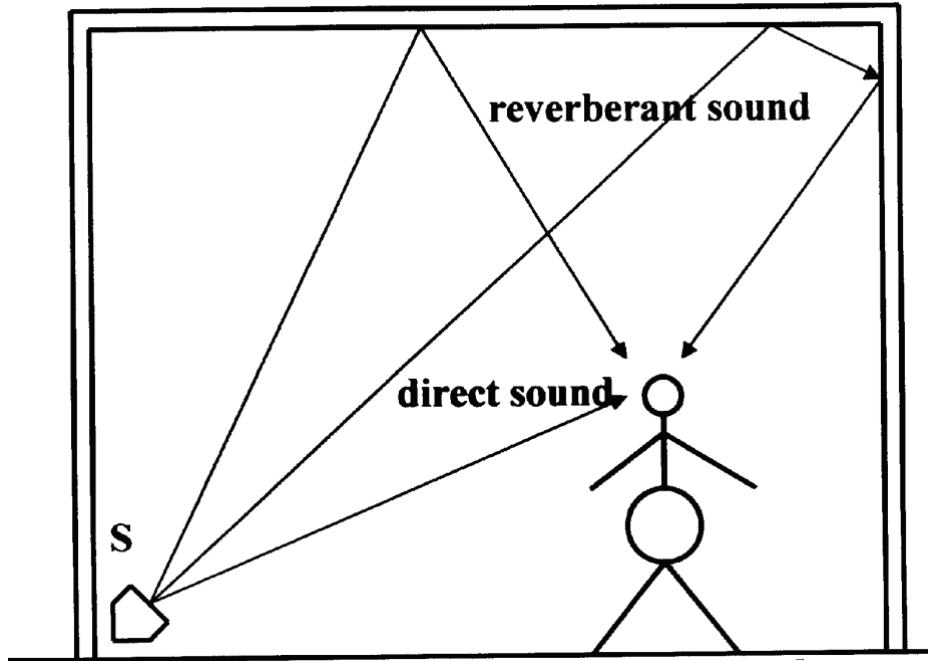
A 15 m<sup>2</sup> façade consists of 14 m<sup>2</sup> wall with 1 brick size plastered wall with SRI of 56 dB and 1 m<sup>2</sup> single glazed window with SRI of 26 dB, both at 1000 Hz. Find the Area Weighted Average SRI of this façade.

$$\text{Sound Transmission of the brick wall} = \tau_{s(\text{brick wall})} = \frac{\text{antilog}(-56)}{10} = 2.51 \times 10^{-6}$$

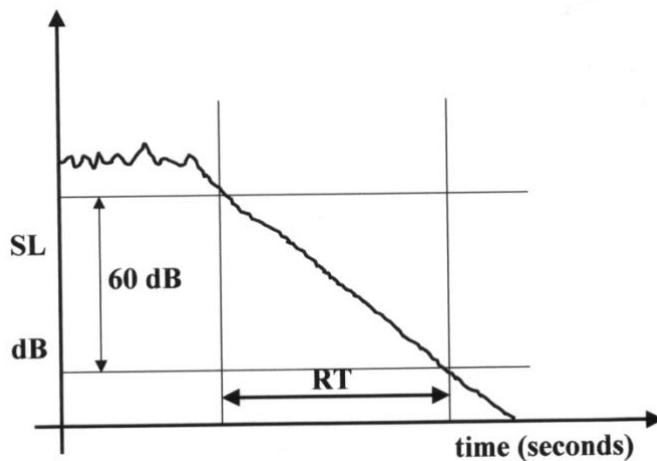
$$\text{Sound Transmission of the window} = \tau_{s(\text{window})} = \frac{\text{antilog}(-26)}{10} = 2.51 \times 10^{-3}$$

$$\begin{aligned} \text{Area Weighted Average Sound Transmission} &= (\overline{\tau_s}) = \frac{(14 \text{ m}^2 \times 2.51 \times 10^{-6}) + (1 \text{ m}^2 \times 2.51 \times 10^{-3})}{15 \text{ m}^2} \\ &= 1.675 \times 10^{-4} \end{aligned}$$

$$\begin{aligned} \text{Area Weighted Average (SRI)} &= 10(-\log(\overline{\tau_s})) = 10(-\log(1.675 \times 10^{-4})) = 37.7 \text{ dB} \\ \text{Sound Reduction Index} & \end{aligned}$$

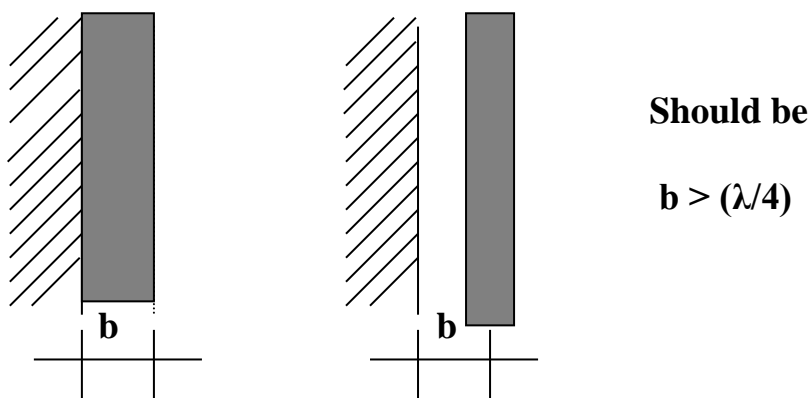


**FIGURE 1.12. Definition of reverberant and direct sound.**

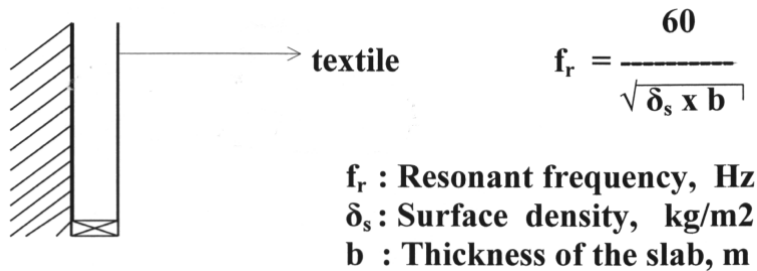


**FIGURE 1.13. Definition of reverberation time**  
**1.4.3.6. SOUND ABSORBERS**

**POROUS ABSORBERS:** Such as glass wool, rock wool, fibre board, plastic foams which have open pores, and carpet. They are effective for high frequency sounds.

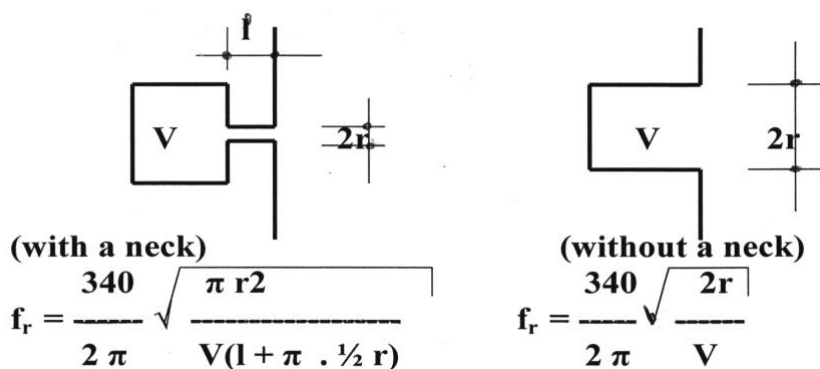


**MEMBRANE ABSORBERS** are produced by stretching flexible sheets or thin rigid panels over supports, at some distance in front of a solid building element. They are effective at low frequencies and at their resonant frequency.



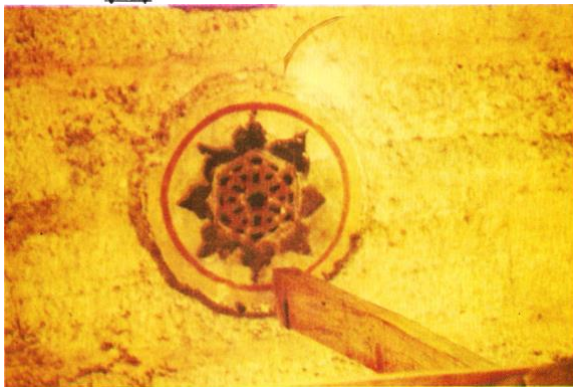
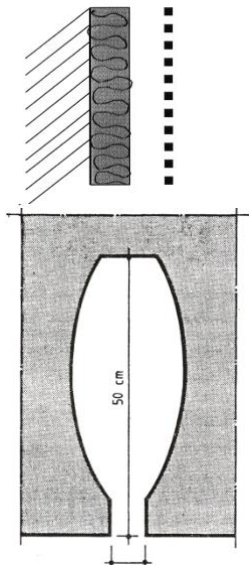
### CAVITY ABSORBERS (HELMHOLTZ RESONATORS)

They are effected at a very narrow frequency spectrum. They can be of two types, with or without a neck. There should be many of them on a surface. When the sound passes from the opening they act like a spring and absorb the sound. Below you will see sections of one resonator from each type. They are good absorber for frequencies equal to their resonant frequency. These resonators were named after Hermann von Helmholtz a Prussian physicist who lived in the 19<sup>th</sup> century because he made the necessary calculations of them. However, they were known in architecture from the ancient times on. Even Mimar Sinan used them in some of his mosques. He used large earthenware jars on the domes with their open mouths flush with the inner surfaces. Sometimes ornamental perforated lids were also used. Please look at Figures 1.14.



### PERFORATED PANEL ABSORBERS

They are formed by putting a perforated thin plate made of plywood, chipboard, timber or gypsum in front of a solid building element with an air space. They combine the mechanism of the first three types of absorbers. They absorb a broader frequency spectrum.



**FIGURE 1.14. Large earthenware jars used by Mimar Sinan at the domes of some mosques. (Kayılı, 1989).**

Actually, Sinan did not only used jars on the roof, he used a light rendering called “horasan”, ornamental figures called “mukarnas” between the corners of walls and roof.

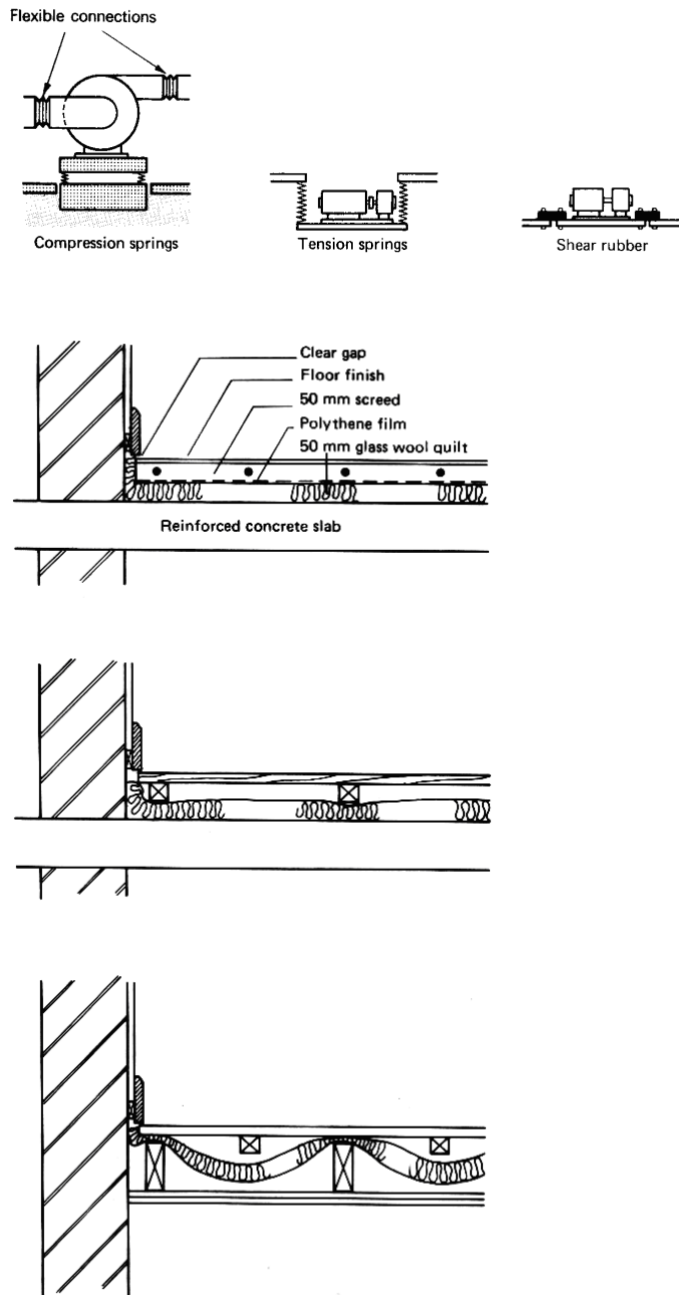
#### **1.4.4. NOISE CONTROL INDOORS**

Noise indoors is caused mostly by a vibrating machine.

- A slanting machine will make more noise.
- A loose screw will make the machine generate more noise.
- Placing the noise making machines on springs or rubber feet will avoid structure borne noise (Fig.1.13).
- Placing the noise making machines inside a sound absorptive box will reduce airborne noise.
- Placing the machines on the rigid part of the structure will prevent the vibrations and thus the structure borne noise.
- Using floating floor in multi storey apartments will reduce the noise passing to the lower floor.



- Use of sound absorbent surfaces on walls, floors and ceilings will reduce airborne noise.
- Use of sound insulative building elements will reduce the sound being transmitted to the other side.

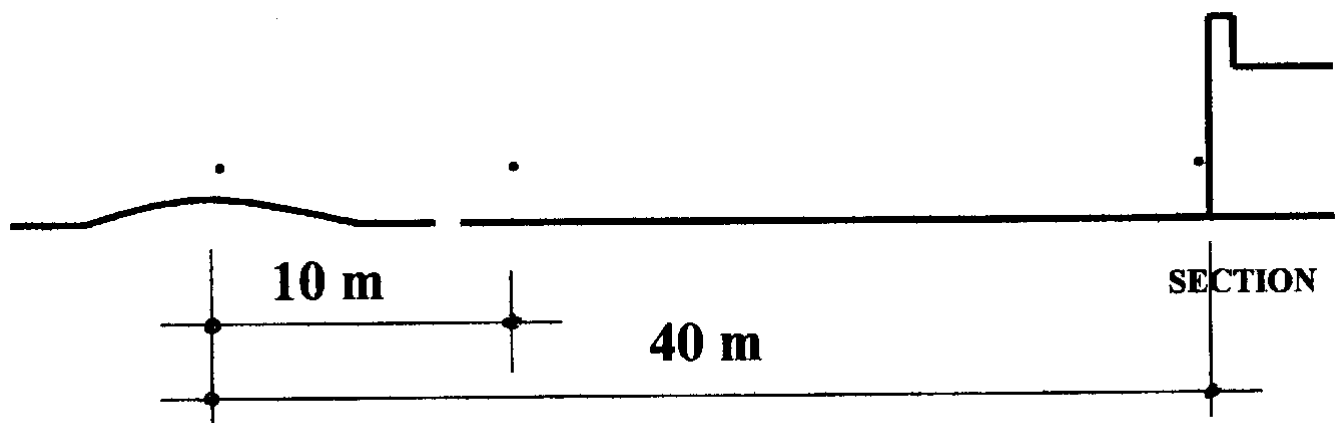


**FIGURE 1.15. Flexible mountings for constructions.**

### 1.4.5. CONTROL OF NOISE WITH THE EXTERIOR BUILDING ELEMENTS

When we wish the noise outside the building do not enter the building, we should first decide how much sound insulation we need. The exterior building element should have SRI as much as the needed sound insulation. This can best be illustrated by an example.

A conference hall will be constructed 40 m away from the centre of a road. Sound levels measured 10 m away from the centre of the road are given at following table. Find the thickness and materials for the external wall of this conference hall.



Frequency, Hz	63	125	250	500	1000	2000	4000	8000
1. SL at 10 m, dB	98	95	89	85	81	77	71	64
2. SL at 40 m, dB	86	83	77	73	69	65	59	52
3. NR = 25	55	44	35	29	25	22	20	18
4. Necessary sound insulation (Line 2 – line 3)	31	39	42	44	44	43	39	34
5. SELECTION (1 brick size plastered wall)		41	45	48	56	58	62	

## **1.5. ROOM ACOUSTICS**

Room acoustics is a branch of acoustics which deals with good listening conditions at halls. The halls and the auditoriums are divided into three categories.

1. Those for speech.  
(Like lecture halls, conference halls, theaters etc.)
2. Those for music.  
(Like concert halls, dance theaters, etc.)
3. Multipurpose auditoriums.  
(Auditoriums which are used both for theatrical and musical performances.)

### **1.5.1. AUDITORIUMS FOR SPEECH**

It is relatively easy to solve acoustic problems of lecture halls and conference halls. Because the most important requirement is to reinforce the speaker's voice towards the middle and back seats. This can be achieved with sound reflective surfaces on walls and ceilings. In most halls for speech a loudspeaker system is used.

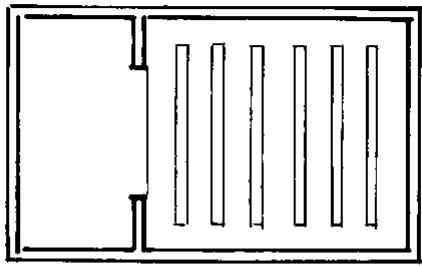
Theaters are also auditoriums for speech. However, in theaters in addition to good listening conditions, a good spectator-player relationship should be achieved.

#### **1.5.1.1. SPECTATOR – PLAYER RELATIONSHIP**

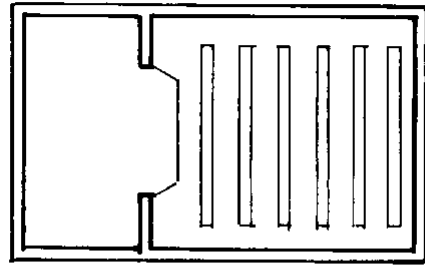
The plan types of the early theaters were like the cinemas of our days. Their stage was on one side and the audience on the other. This is called end stage type plan. When the stage projects out a little bit it is called proscenium or front stage type plan. Both at the end stage and the front stage plan types spectators move away from the stage. In the spectator hall 30 – 37 meter depth is needed in order to seat 1000 to 2000 people.

As the depth increases it becomes difficult for the players to influence the spectators and the spectator-player relationship diminishes. Balcony may be needed in order to seat the spectators close to the stage.

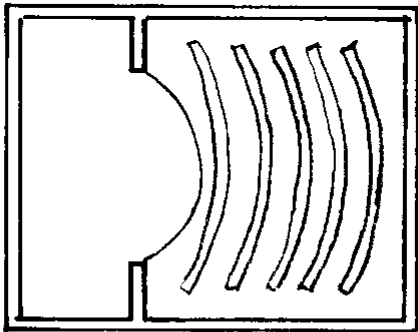
Open stage type plan is the one in which the main stage projects circularly towards the spectator hall and the seats surround it. In this plan type there are acoustical difficulties since the players have to make their voices heard by all the surrounding spectators. However, player - spectator relationship is easily achieved by seating them partly around the open stage. In this arrangement it is possible to seat 1000 to 2000 people in 11 to 19 meter depth.



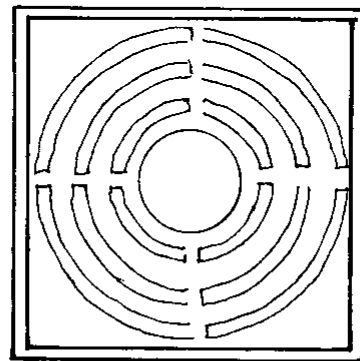
**END STAGE**



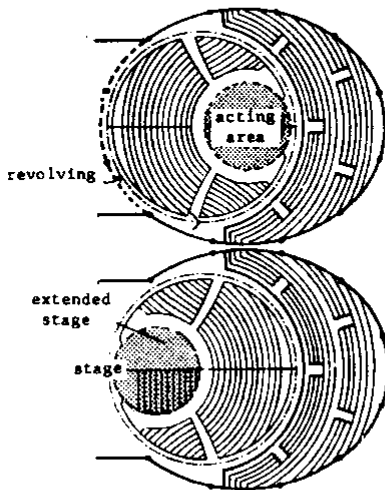
**PROSCENIUM (FRONT STAGE)**



**OPEN STAGE**

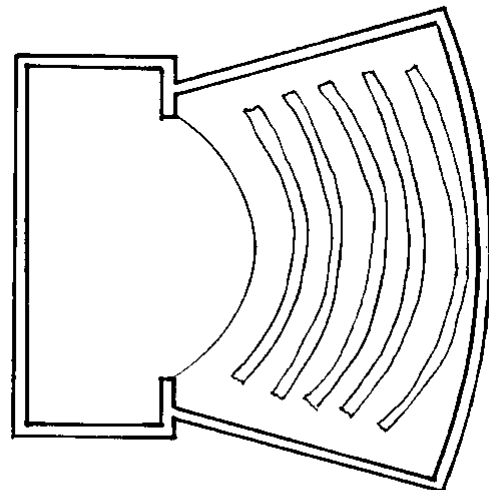


**ARENA STAGE**



'Totaltheatre' Sc.1:1 600  
by Gropius with revolving  
centre. Plan shows  
both positions.

**VARIABLE STAGE**



**PRESENT TENDENCY  
IN THEATER DESIGN**

**FIGURE 1.17. Developments in stage arrangements.**

Arena stage type plan has been derived from classical amphitheatres. It requires very simple stage decorations. Decorations are symbolic sometimes made of sticks. It is very cheap to stage a play in this plan type. Spectator – player relationship can be easily established. However, there are acoustical difficulties since it is not easy to be heard by all the spectators around the stage. This difficulty can be solved by using a loudspeaker system at the stage.

Variable stage type plan was proposed by Gropius and some other architects. Different stage and seating plans are applied by movable seats and floors. It requires variable sound absorber and reflector surfaces. It also requires an acoustical expert for all demonstrations. It is a challenge to solve auditoriums for multi purposes. However, the idea of variable stage plan type has shown too many acoustical problems and it is not widely used in our days.

End stage and arena stage plan types are the two extreme solutions for theatres. At present open stage type plans are more appropriate to the modern plays and are preferred by the players because player – spectator intimacy can be established easily.

#### **1.5.1.2. GOOD LISTENING CONDITIONS**

In auditoriums for speech the second problem is to achieve good listening conditions. There are five criteria to achieve it.

1. Loudness should be the same all over the auditorium.
2. Sound energy should diffuse homogenously all over the auditorium.
3. The Reverberation Time should be appropriate for the purpose of the auditorium.
4. There shouldn't be any acoustic distortions like  
echo,  
flutter echo,  
acoustic shading,  
sound focusing,  
whispering gallery,  
room resonance being within the audible frequencies.
5. All the noise and vibrations should be avoided.

Lets study all these criteria in terms of auditorium design.

1. What is meant by this criteria is that all the frequencies of sound should be heard in every part of the auditoriums. It is possible that some frequencies, especially the high frequency sounds, decay if there is any acoustic shadow in the auditorium. Secondly at positions behind a speaker some frequencies

may not be heard. This is why we don't put seats at an auditorium outside an angle of 140 degrees facing the speakers.

2. The designer's aim is to get most of the sound emitted by the speaker to the audience directly and evenly. However, the sound is absorbed as it moves away from the source. In a flat floored room only a small portion of the sound emitted reaches the audience directly. If the speaker platform is elevated more sound will reach the audience directly. If at the same time a raked floor is used for the audience hall even more sound will reach the audience directly.

Another way to increase the sound energy towards the middle and back seats is to use reflective surfaces both on the walls and the ceilings. Sound mostly reflects like light, i.e., incidence angle being equal to reflection angle. Thus, it is possible to find the angle of the surfaces to reflect sound to the required points in auditoria to reinforce it. Since the front seats hear the speakers easily sound is reflected towards the middle and back seats. It is not recommended to direct all the reflective surfaces just to one point. The same approach is utilised to find the slopes of the reflective surfaces at the ceiling.

Reflective surfaces should not be less than approximately 3 meters wide, otherwise, they may diffuse some low frequency sounds.

If the width is larger than the depth of the auditorium, it is better not to use reflective surfaces on side walls. In this case, reflective surfaces can be used at the ceiling only.

3. Reverberation time is an acoustic property of the auditoriums. It is normally the period of time in seconds for a sound to decay 60 dB when the sound source is switched off. The required reverberation time is lower for speech auditoriums and higher for music auditoriums and depends on the volume of the hall. The required reverberation time is also different for different types of music.

Although the reverberation time is the mostly used acoustic parameter for auditoriums there are some other parameters like Early Decay Time, Lateral Efficiency, Clarity, Ratio of Early-to-Late Energy, Early Lateral Energy Fraction etc. which are used at present.

There are a number of acoustic distortions in auditoriums. Echo is hearing the same sound twice. It occurs if the difference of the distance between the direct sound and first reflected sound travels is more than 20 meters. In the early stages of design, this can be eliminated by studying the sections and plans of the auditoriums. In auditoriums back walls, corners of walls and ceilings can

cause echo. So these surfaces must be covered with sound absorbent materials. It is also possible to avoid echo. some other measures. As in the example of back walls sound diffusing forms may be used in order not to reflect the sounds or at the corners

sound may be reflected to some other absorbent surfaces .

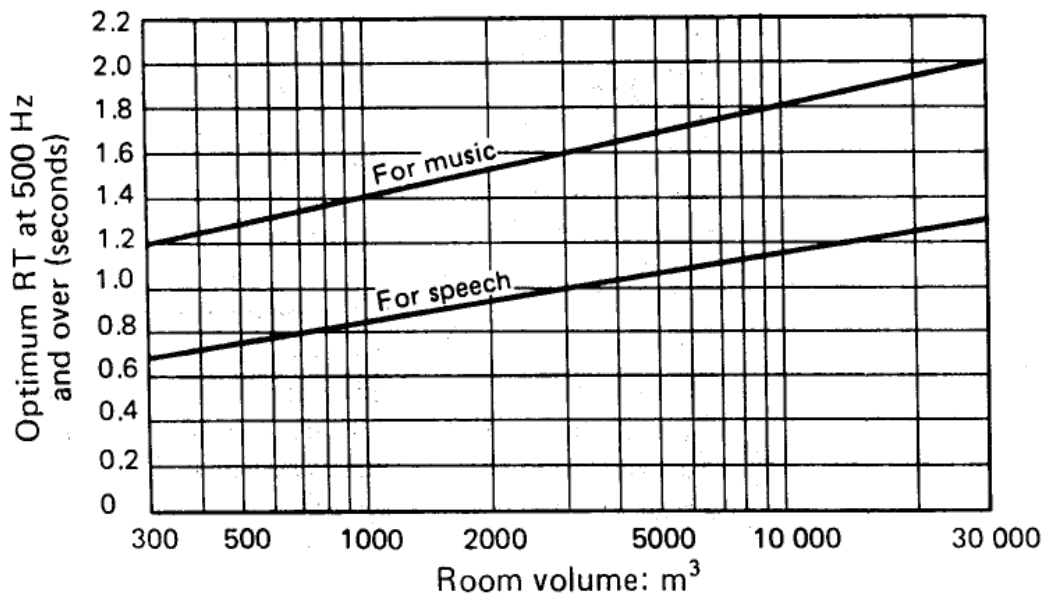
Flutter Echo is the continuous reflection of sounds between parallel surfaces. It commonly occurs at the parallel side walls of the auditoriums. It can be eliminated if the side walls are made divergent, at least  $3^\circ$  from the longitudinal axis on each side.

Acoustic shade occurs under the balconies of the auditoriums. As a result especially the high frequency sounds diminish. It can be eliminated by using sound reflective suspended ceiling under the balcony. Acoustic shadow also occurs behind some projections like lighting bridges on the ceilings and some sounds are not reflected. Thus it is possible for some middle seats not to get enough sound while the people behind these seats hear the sounds very well. This can also be eliminated by a careful study of the auditorium sections and plans and by avoiding sound barrier type projections.

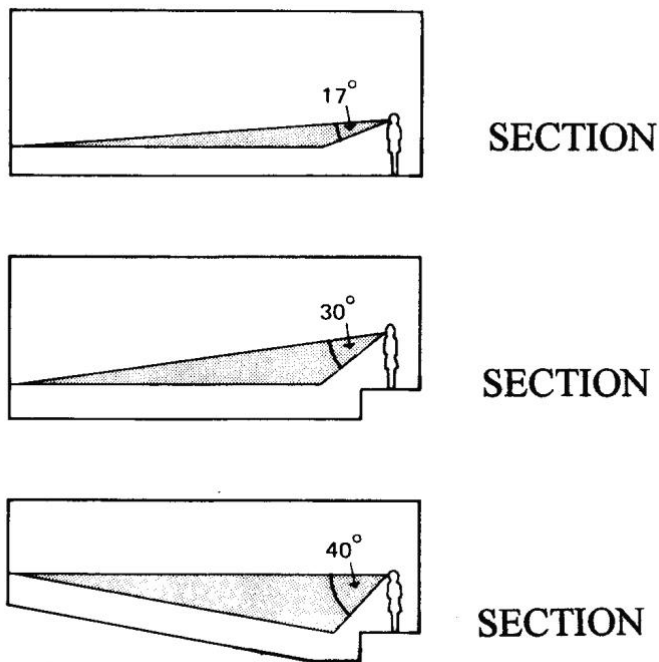
Sound Focusing accumulation of sounds coming from different points at a certain point. It occurs within concave shapes. It can be eliminated by using sound absorbent surfaces. However, if this is done sound must be reinforced either by sound reflective surfaces at the ceiling or by a loudspeaker system.

Whispering gallery is another acoustic distortion associated with circular plan type. Sounds may be reflected continuously at the perimeter walls of a circular auditorium and heard on the other end of the building. This can be eliminated by using decorative projections on circular walls.

4. All the noise whether they are produced within the auditorium or outside should be reduced to the acceptable level.

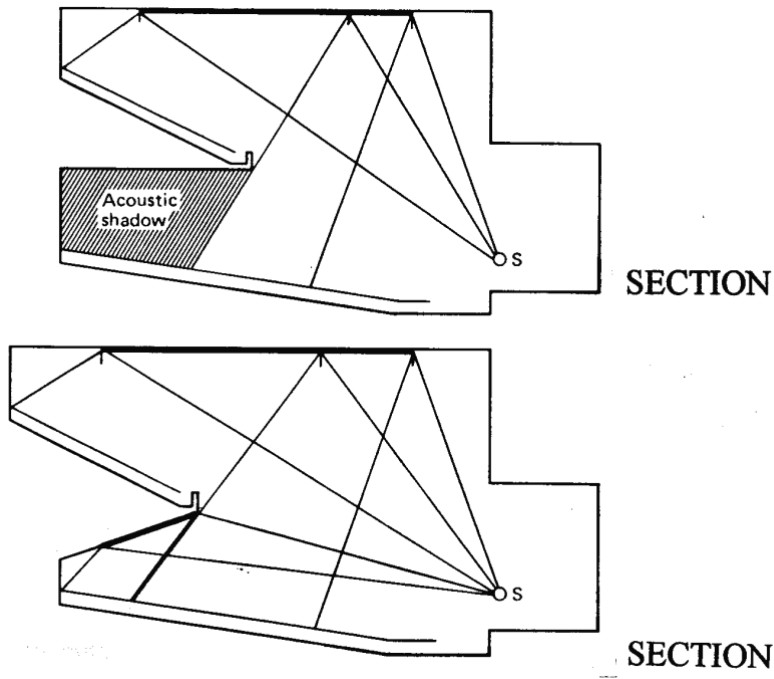


**FIGURE 1.18 . Optimum reverberation times for auditoriums.**



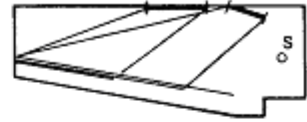
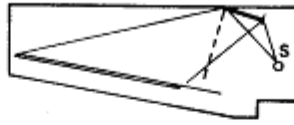
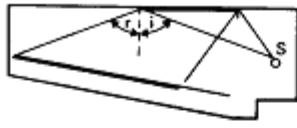
**FIGURE 1.19. Sound distribution as affected by sectional shape.**



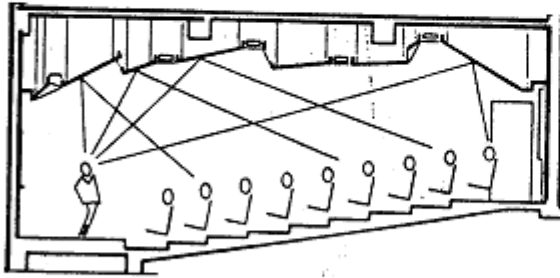


**FIGURE 1.20. Acoustic shadow caused by balcony.**

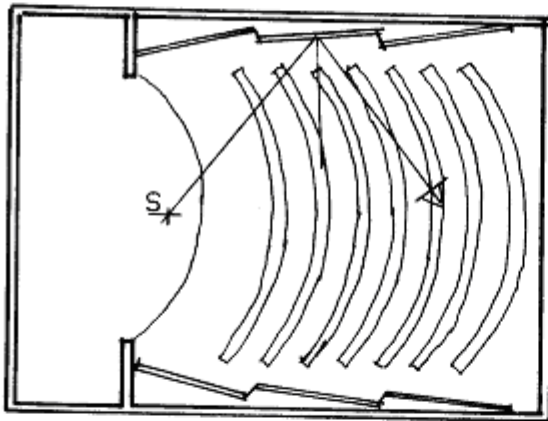
Reinforcement by reflection.



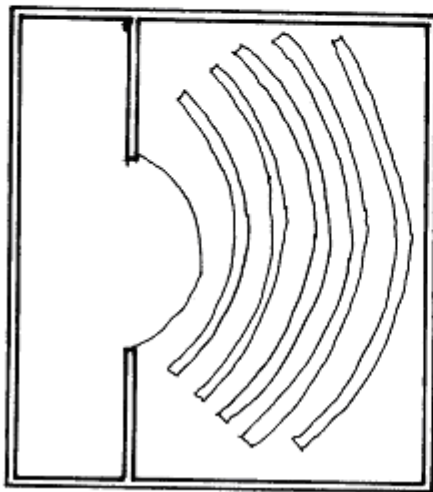
SECTION



SECTION



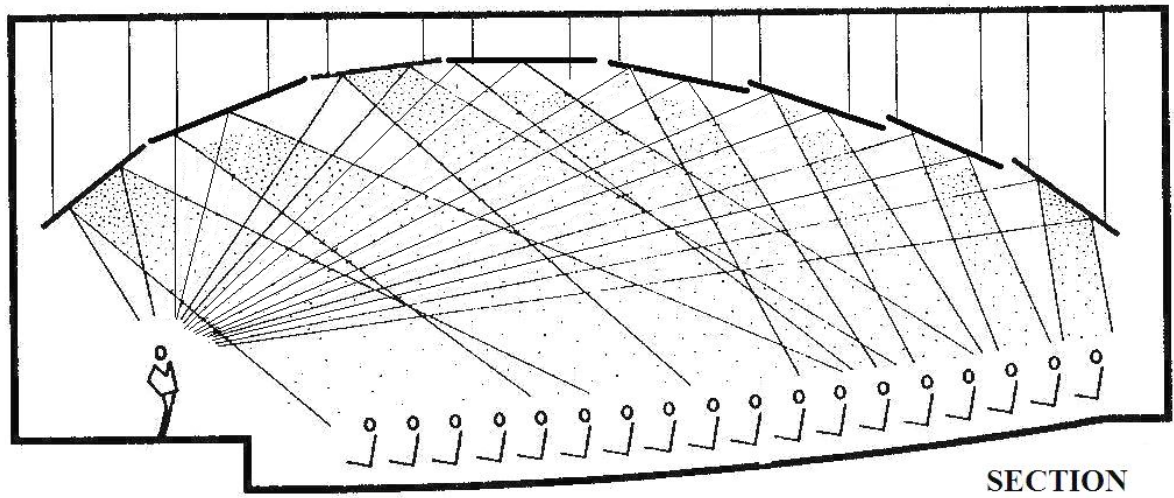
PLAN



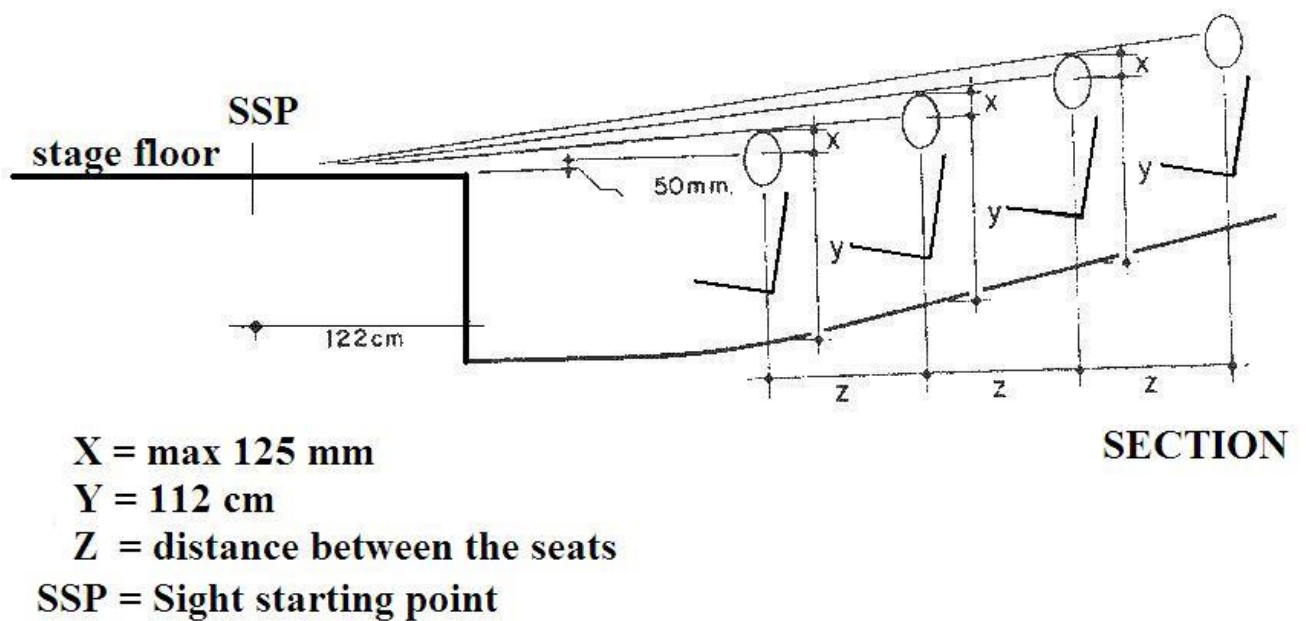
WIDE AUDITORIUM

PLAN

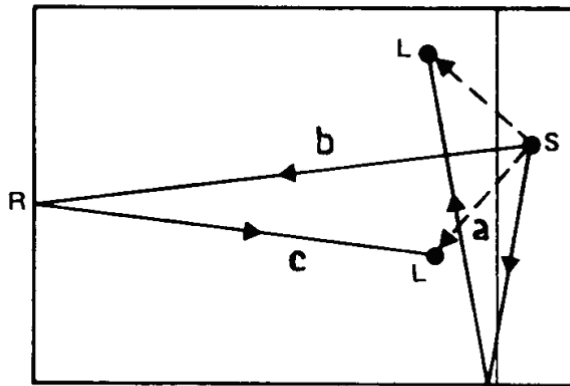
**FIGURE 1.21 . Design of sound reflectors (In wide auditoriums reflectors are only used on ceilings not at the side walls).**



**FIGURE 1.22. Reinforcement of sounds by reflectors on the ceiling.**



**FIGURE 1.23. Designing the auditorium section according to the visual function.**



For  $(b+c) - (a) \geq 20$  meter

FIGURE 1.24 . Formation of echo.

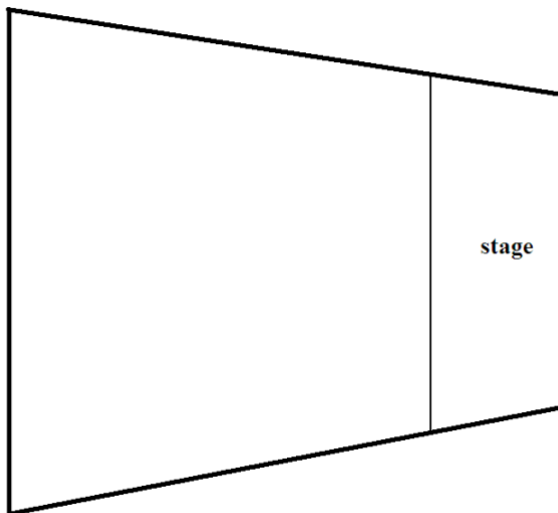
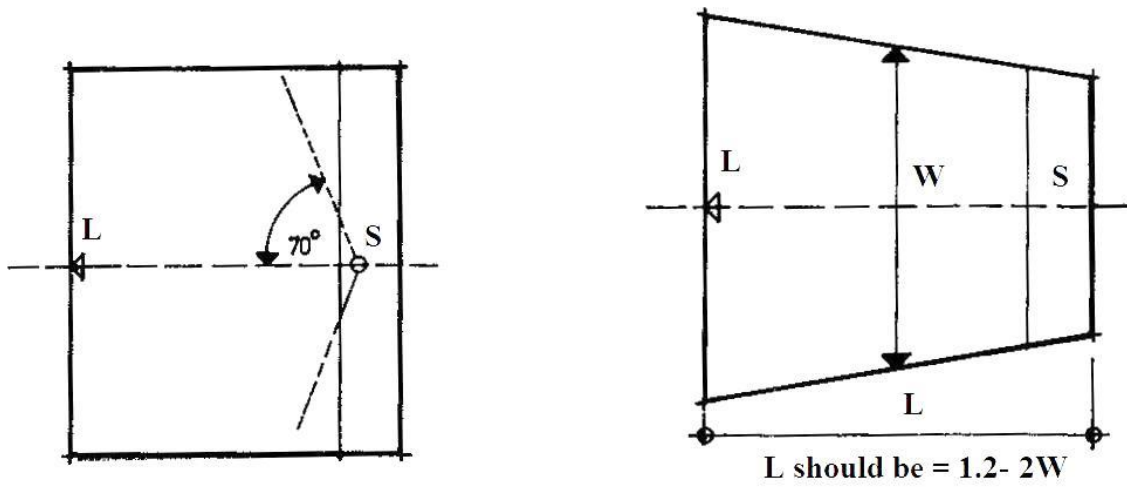
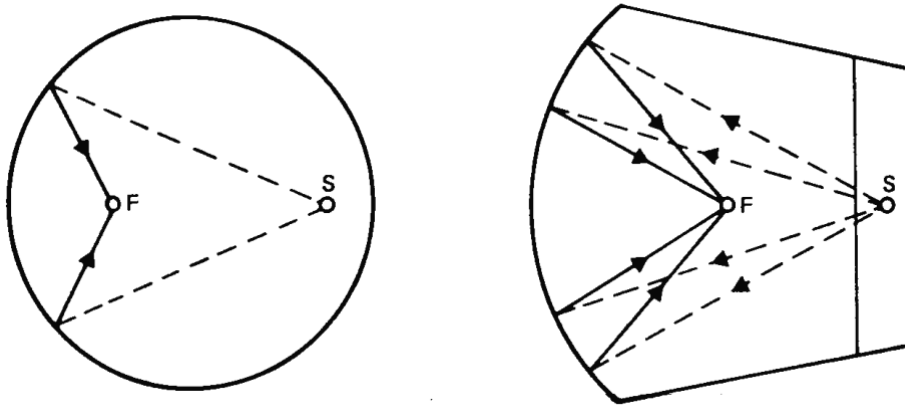


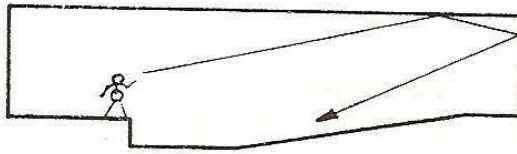
FIGURE 1.25 . Elimination of flutter echo by fan shaped plan.



**FIGURE 1.26 . Proposals for auditoriums.**

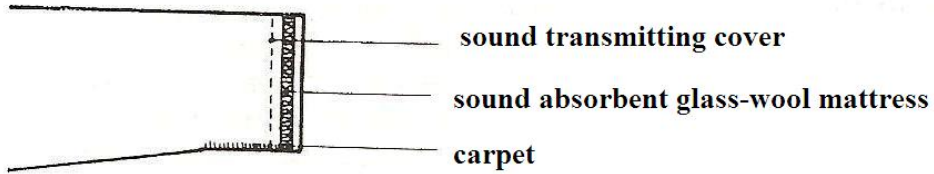


**FIGURE 1.27 . Concave forms causing focusing effect.**

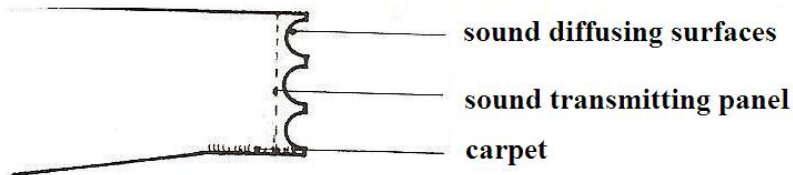


**PROBLEM :** Back auditorium wall causing echo.

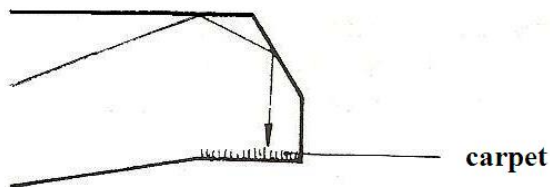
**SOLUTION 1.**



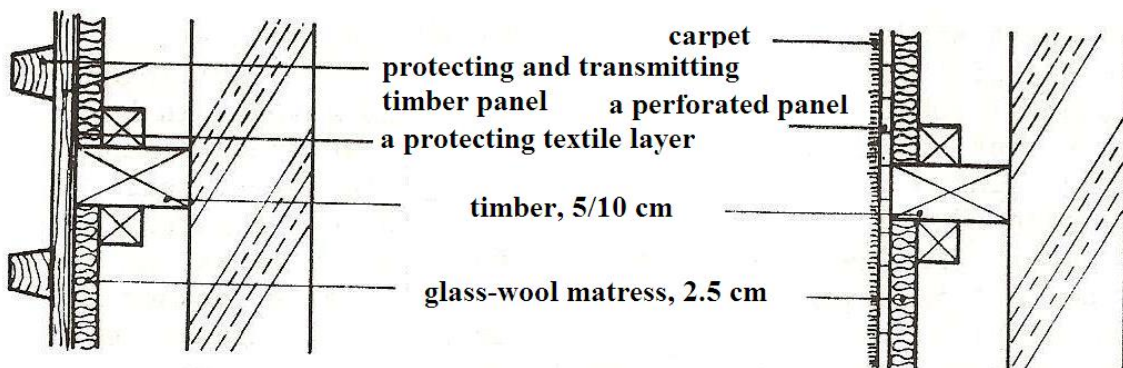
**SOLUTION 2.**



**SOLUTION 3**



**TWO DIFFERENT DETAILS FROM BACK WALLS**



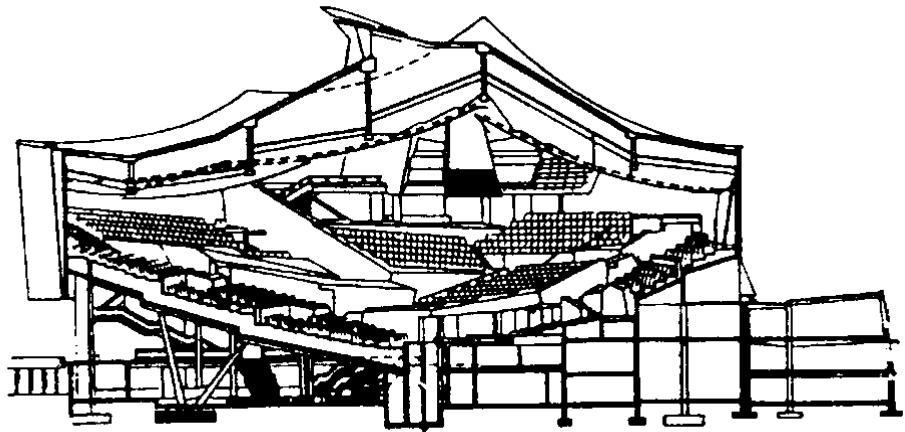
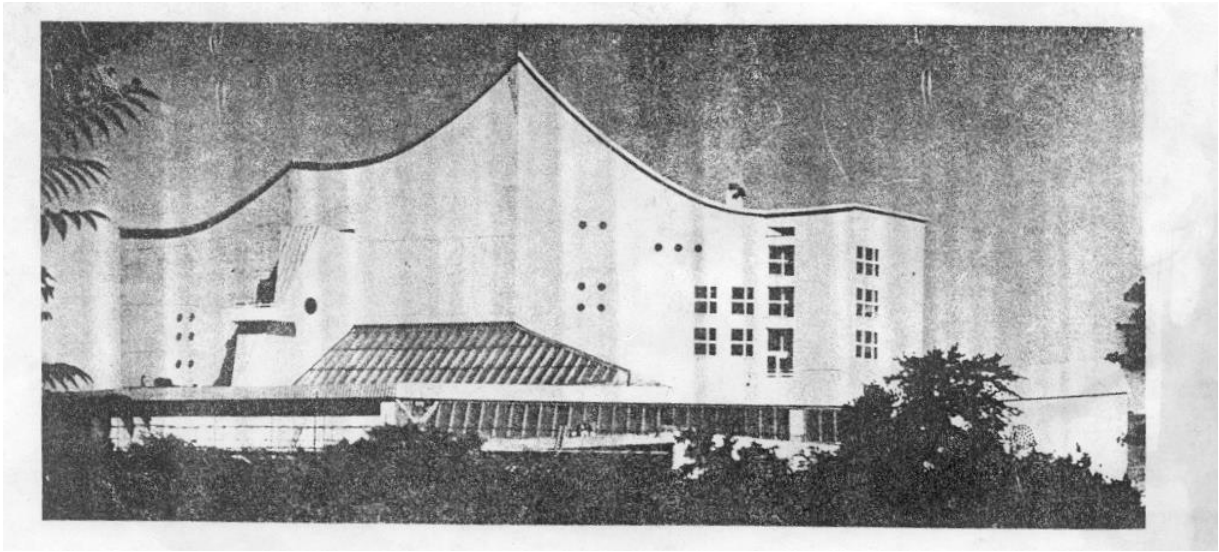
**FIGURE 1.28 . Elimination of echo on the back walls.**

### **1.5.2. AUDITORIUMS FOR MUSIC**

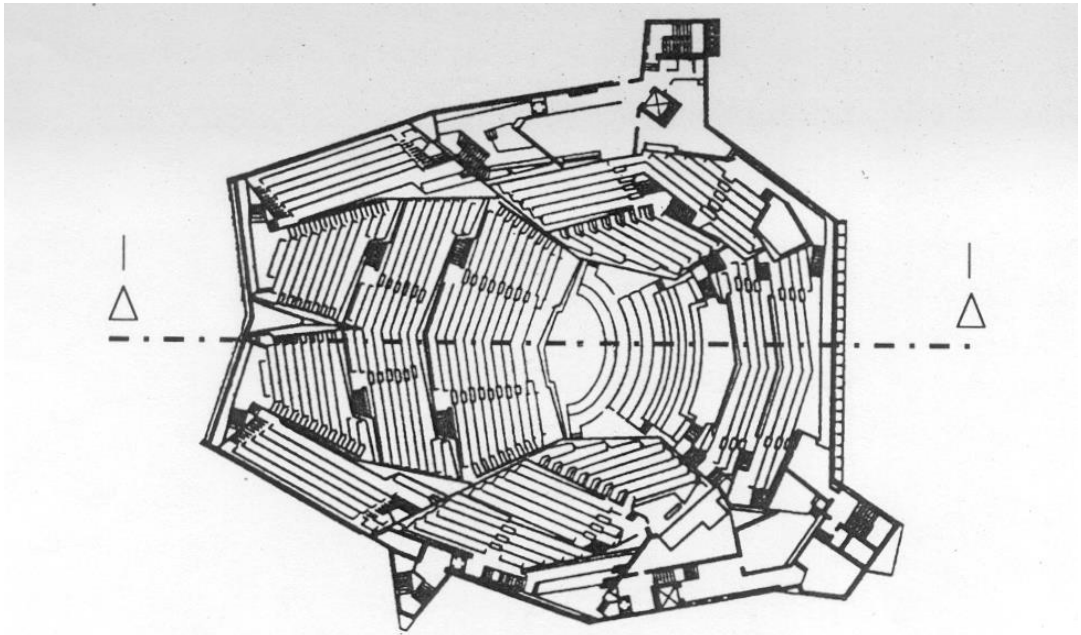
In addition to GOOD LISTENING CONDITIONS which were explained for the auditoriums for speech, a balance between SOUND REFLECTION and SOUND DIFFUSION should be achieved, because a concert is not only MUSIC. It is at the same time a SHOW. Berlin Philharmonie Hall designed by Scharoun is a very successful experiment of this balance. In this plan type the stage is at the centre of the auditorium. There are seats in front of the stage, however there are many seats on balconies surrounding the stage. So that people can watch the musicians and the conductor from different angles. All these balconies and the other forms on the ceiling and the walls help to diffuse the sound which is more needed at auditoriums for music. The low side walls of the balconies provide side reflected sound for the listeners on them. This plan type for a music auditorium which is called “Vineyard plan type” was first applied by Schaurun, later many other architects used the same idea with success.

### **1.5.3. MULTIPURPOSE AUDITORIUMS**

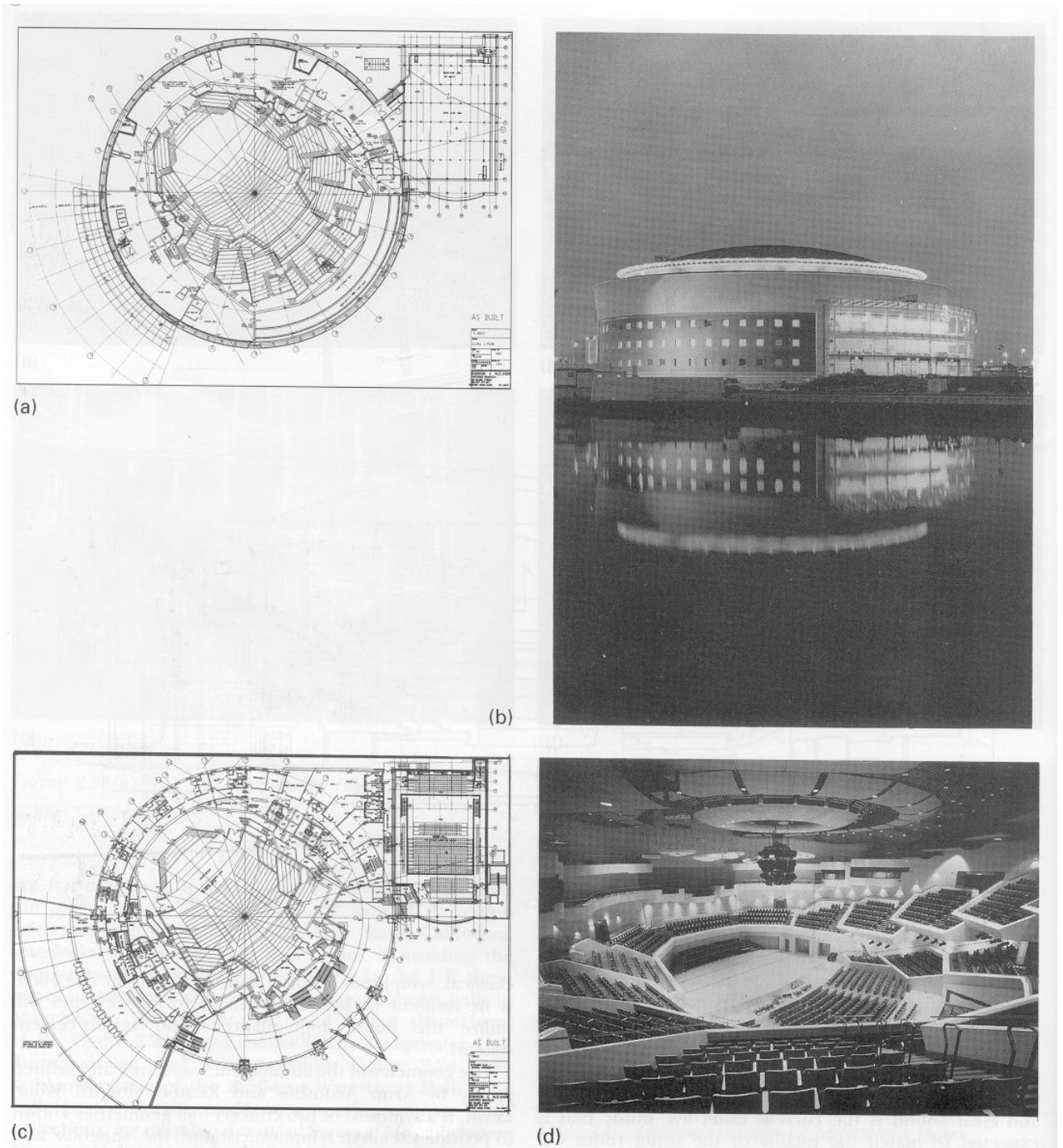
Acoustically multipurpose auditoriums are not preferred, because acoustical requirements are different for speech and music auditoriums. There are variable sound reflectors and diffusers. These require an acoustician for the auditorium and it is not always feasible to do it. Still if it is decided to design a multipurpose auditorium there should be both sound reflectors and absorbers distributed all over the auditorium.



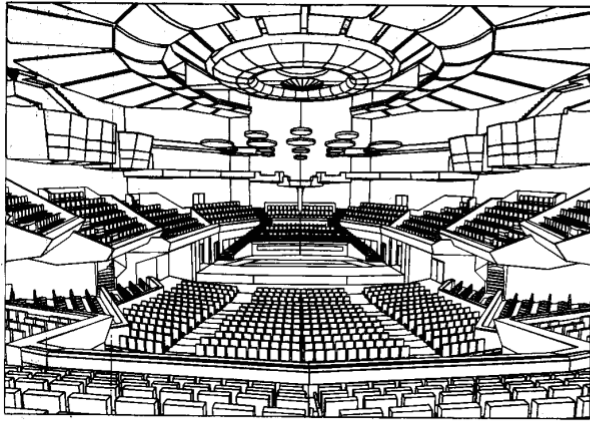




**FIGURE 1.29 . Hans Scharoun, Berlin Philharmonie Hall, 1963**



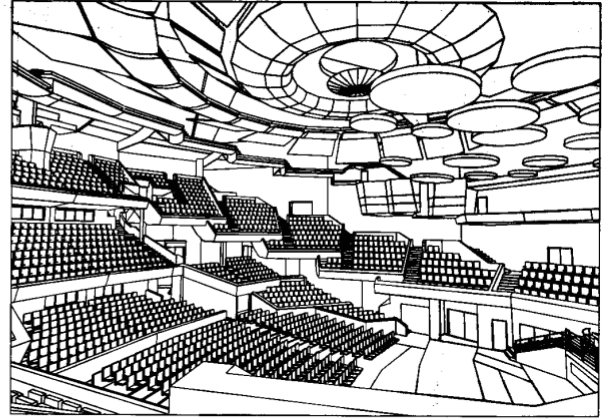
**FIGURE 1.30 a – d . The Waterfront Hall, Belfast**



WATERFRONT HALL

AUDITORIUM LOWER CIRCLE

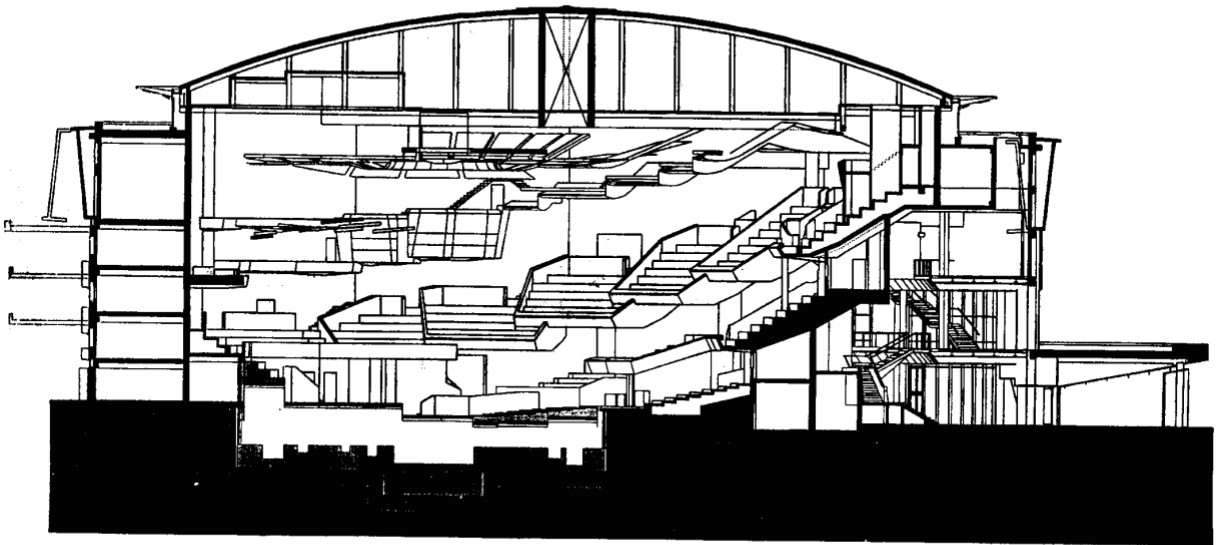
(e)



WATERFRONT HALL

AUDITORIUM UPPER CIRCLE

(f)

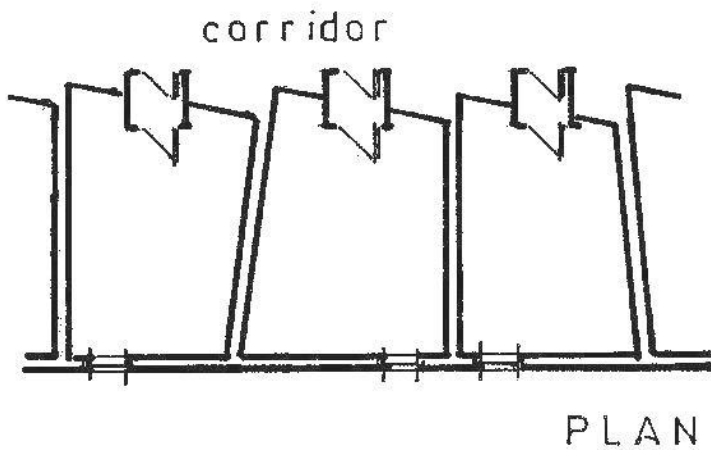


AUDITORIUM SECTION

(g)



FIGURE 1.30 e – g . The Waterfront Hall, Belfast.



PLAN

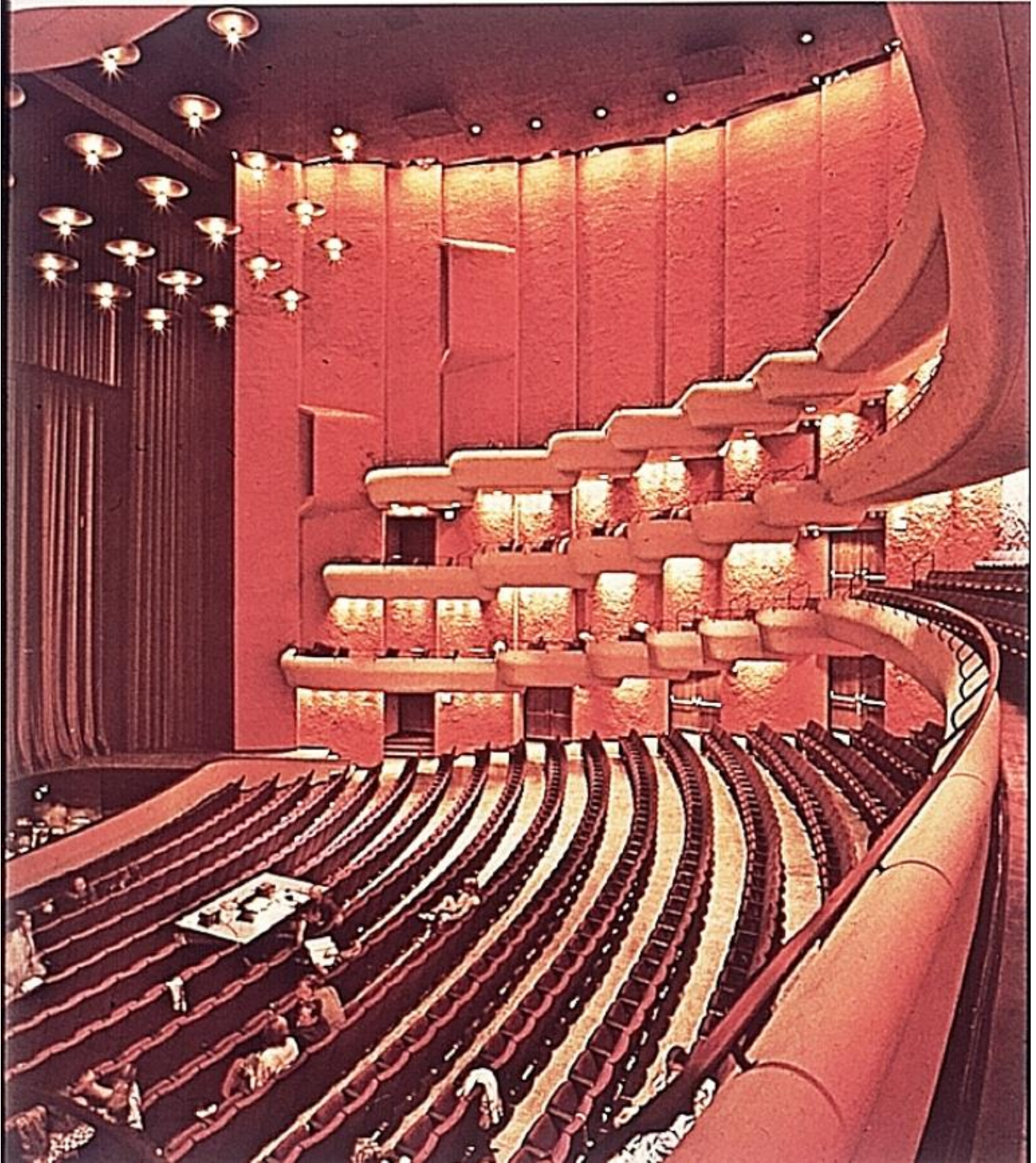
FIGURE 1.31. Design of music practice rooms.





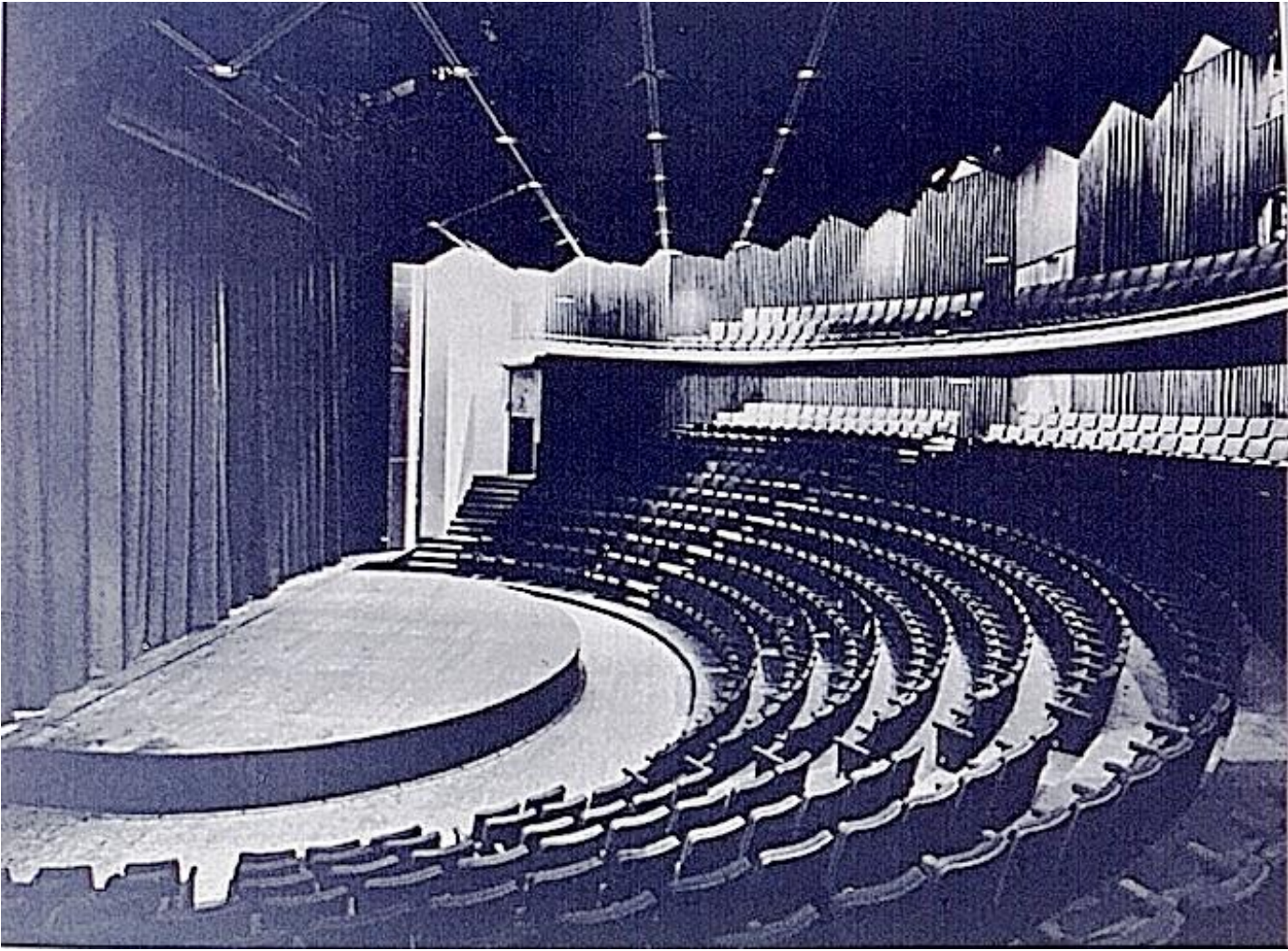
**FIGURE 1.32. A Multipurpose Wide Auditorium.**





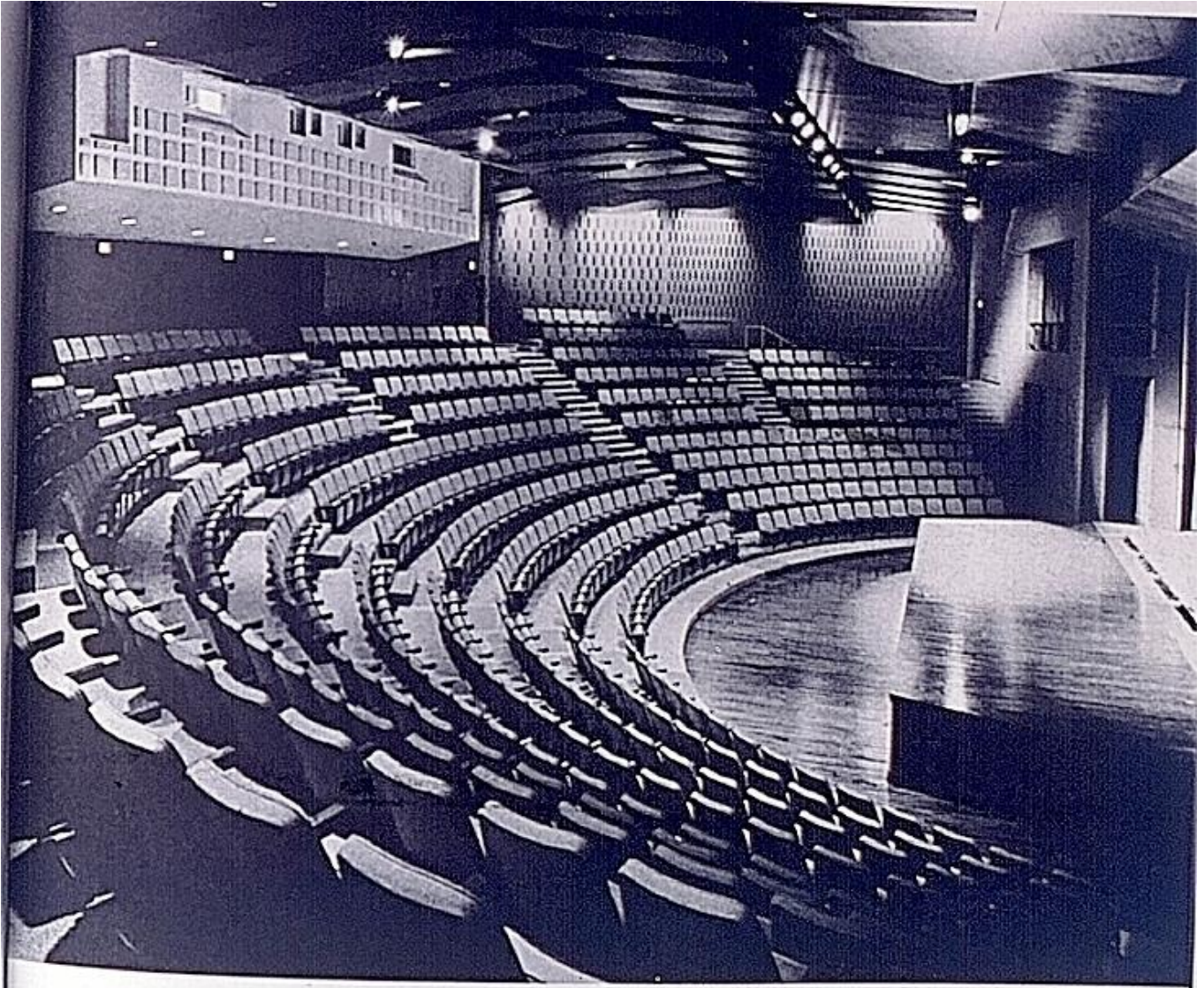
**FIGURE 1.33. Indiana University, Musical Arts Center, Woolen Associates, 1965**





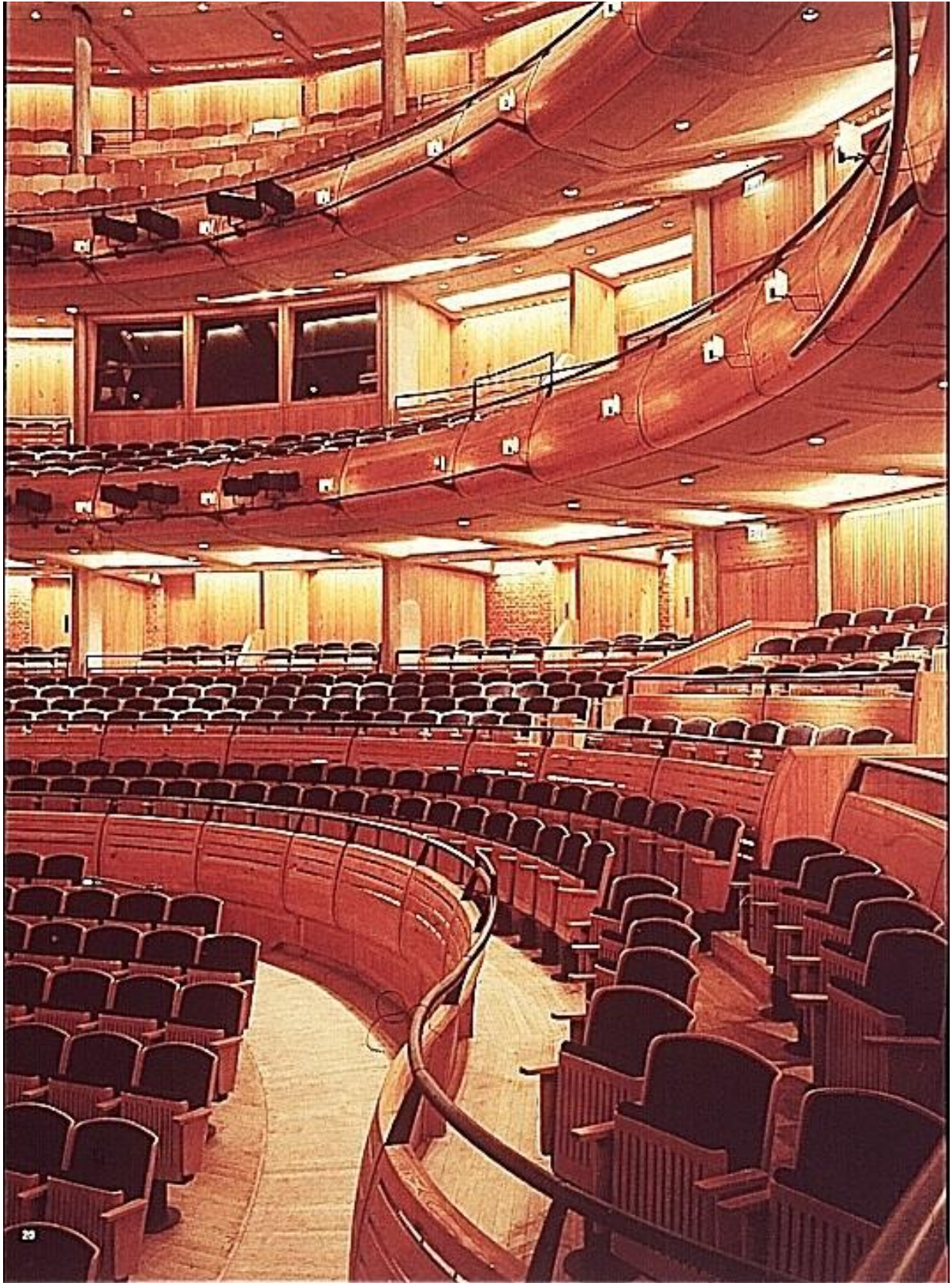
**FIGURE 1.34.** An 800 seat open stage theatre. Theater of the National Arts Center, Ottawa, Canada.





**FIGURE 1.35. Bishops University, Quebec, Theater**





**FIGURE 1.36. Elimination of whispering gallery effect. Glydebourne Opera House, 1200 seats.**